

↓
New
Prices



Bistro-Beschilderung



Say it with quality









TABLE DES ICÔNES

	Secouez		Compatible avec 1 batterie Securit®
	Presser avant utilisation		Compatible avec 2 batteries Securit®
	Écrivez sur la surface		Télécommande LED incluse
	Mouillez une éponge		Rotatif 90°
	Effacez à l'eau		4 Points de connexion
	Vis incluses		4 Points de connexion
	Charnières pour accrochage mural incluses		Stable
	2 Crochets pour suspension murale inclus		Charnières Securit® avec verrou de sécurité incluses
	2 Crochets de suspension murale inclus		Vitre de sécurité
	Fil de suspension murale inclus		Surface d'écriture amovible
	Pièces adhésives scratch de fixation incluses		Résiste à la pluie et aux UV
	Ampoules LED incluses		Prises électriques UK, USA, CH, EU incluses

Tous les prix contenus dans ce catalogue sont des prix publics conseillés hors taxe.

TAILLES

						
A8	A7	A6	A5	A45	A4	Letter
5,2 x 7,4 cm	7,4 x 10,5 cm	10,5 x 14,8 cm	14,8 x 21 cm	29,7x14,8cm	21 x 29,7 cm	21,6 x 27,9 cm



CHEVALETS DE TABLE

P. 4-11



ÉTIQUETTES ARDOISES

P. 12-15



PANCARTES SILHOUETTE

P.16-17



PANNEAUX TROTTOIR

P. 28-33



ARDOISES MURALES

P. 18-27

FEUTRES-CRAIES

P. 34-37



PROTÈGE-MENUS

P.38-49



PORTE-AFFICHES

P. 51-51



POTEAUX D'ACCUEIL

P. 58-59



CENDRIERS EXTÉRIEURS

P.60-61



PRÉSENTOIRS ÉCLAIRÉS

P.52-57





SILHOUETTE - ALUMINIUM



+



Ardoise Silhouette de table Securit® avec base en aluminium. 13 formes différentes pour s'adapter à chaque environnement. A poser sur une table ou un bar pour attirer l'œil de vos visiteurs. Utilisable recto-verso. Ardoise amovible. Un feutre-craie à encre liquide Securit® inclus.



FBTA-A4
29x21x6cm



FBTA-MENU
34x21x6cm



FBTA-WINE
35x33x6cm



FBTA-COCKTAIL
35x21x6cm



FBTA-CHEF
35x22x6cm



FBTA-ICECREAM
27x25x6cm



FBTA-BEER
34x22x6cm



FBTA-CUP
21x34x6cm



FBTA-PLATE
24x25x6cm



FBTA-CHAMPAGN
35x23x6cm



FBTA-PIZZA
25x34x6cm



FBTA-BURGER
25x27x6cm



FBTA-SANDWICH
25x33x6cm



SILHOUETTE - BOIS



FBT-PLATE
24x25x6cm

+



Ardoise Silhouette de table Securit® avec base en bois. 10 formes ludiques et originales à poser sur une table ou un bar pour attirer l'œil de vos visiteurs. A utiliser recto-verso. Ardoise amovible. Un feutre-craie à encre liquide Securit® inclus.



FBT-HOUSE
33x21x6cm



FBT-TEAPOT
24x33x6cm



FBT-CUP
22x33x6cm



FBT-PIG
24x30x6cm



FBT-MEMO
35x21x6cm

MINI SILHOUETTE - BOIS



FBT-MIX-3



FBT-TEAPOT-3
≈ 10x12 cm



FBT-CUP-3
≈ 10x12 cm



FBT-PLATE-3
≈ 10x12 cm

+



Lot de 3 petites ardoises de table avec base en bois pour inscrire le numéro de table, le nom de réservation ou même les promotions en cours. A utiliser recto-verso. Ardoise amovible. Un feutre-craie à encre liquide Securit® inclus.





ELEGANT



Nature

ELE-B-LA 7x28x32cm
ELE-B-ME 6x20x23cm
ELE-B-SM 5x16x17cm



Noir

ELE-BL-LA 7x28x32cm
ELE-BL-ME 6x20x23cm
ELE-BL-SM 5x16x17cm

Chevalets de table en bois dur disponible dans 3 formats, petit modèle A6, modèle moyen A5 et modèle large A4. L'ardoise est amovible pour faciliter l'écriture et le nettoyage. A utiliser avec les feutres-craies à encre liquide Securit® (non inclus). Peut être utilisé en extérieur. Ci-dessous, des ardoises supplémentaires sont disponibles.



Teck

ELE-TE-LA 7x28x32cm
ELE-TE-ME 6x20x23cm
ELE-TE-SM 5x16x17cm



Acajou

ELE-M-LA 7x28x32cm
ELE-M-ME 6x20x23cm
ELE-M-SM 5x16x17cm



ELE-S-LA A4 x3
ELE-S-ME A5 x3
ELE-S-SM A6 x3

TOP/POIGNÉE

Chevalets de table en bois dur couleur wengé disponibles dans 4 formats. L'ardoise est amovible pour faciliter l'écriture et le nettoyage. Peut être utilisé en extérieur. A utiliser avec les feutres-craies à encre liquide Securit® (non inclus)



ELE-DB-LA
7x26x40cm



ELE-DB-ME
6x20x28cm



TT-DB-LA
7x21x45cm



TT-DB-XL
7x35x53cm

Ardoise chevalet de table en bois à poignée Securit®, finition marron foncé laqué. Peut être utilisé en extérieur. A utiliser avec les feutres-craies à encre liquide Securit® (non inclus), lavable.



TWISTER

Ardoise de table en bois dur double face fixée sur un support permettant une rotation à 360 degrés. Format A5, finition acajou laqué. A utiliser avec les feutres-craies à encre liquide Securit® (non inclus).



TWI-M-26
9x26x47 cm

Meilleur prix





PRÉSENTOIRS BOUTEILLES

Porte-bouteilles avec ardoises pour présenter vos boissons. Ces présentoirs vous permettront d'indiquer le nom d'un vin (ou toutes autres boissons), son origine, son prix etc... Cet accessoire original apportera une réelle visibilité à vos produits. A utiliser avec les feutres-craies à encre liquide Securit® (non inclus).



WB-WR-1
10x10x45 cm



WB-WR-3
10x38x45 cm



MINI



Nature

3X: MNI-B-KR
24x11 cm



Noir

3X: MNI-BL-KR
24x11 cm



Acajou

3X: MNI-M-KR
24x11 cm

Petits chevalets de table de couleur acajou et nature. Ils pourront composer un joli trio pour présenter vos plats du jour et les autres informations essentielles que vous souhaitez faire partager à vos clients. A utiliser avec les feutres-craies à encre liquide Securit® (non inclus).



JUNIOR

Chevalet trépied au format A4, à placer sur une table ou un comptoir. Également idéal pour présenter des documents A4. A utiliser avec les feutres-craies à encre liquide Securit® (non inclus).

JUN-M-A4
36x22 cm





TAGS SILHOUETTE



TAG-FLOWER-5
5x
7x18 cm



TAG-BUBBLE-5
5x
8x18 cm

Nouveau

+



NOUVEAU : grâce à ces ardoises Securit® «Tags», vous pouvez facilement informer les clients, quelque soit l'endroit! Utilisez-les pour afficher les prix en boulangerie, comme numérotation de table, pour les noms des convives lors de mariages ou encore à la maison pour les plantes aromatiques. Lot de 5, un feutre-craie à encre liquide coloris blanc inclus.



TAG-RECTANGLE-5
5x
8x18 cm



TAG-BUTTERFLY-5
5x
7,5x18 cm





TAGS

Ardoises "Tags" de tailles différentes. Utilisez le feutre-craie à encre liquide Securit® qui est inclus. Disponible en lots de 5,10 ou 20 pièces, selon la taille choisie.



TAG-AB-WT
20x
7,5x5cm



TAG-A7-WT
20x
10x7,5cm



TAG-A6-WT
20x
15x10cm



+



TAG-A5-WT
10x
21x14,8cm



TAG-A4-WT
5x
29,7x21cm

ACCESSOIRES



TAG-HLD-BL
x20
4x6x1,3cm

Nouveau



TAG-HLD-TR
x10
4x6x1,3cm

Supports pour Tag en acrylique ; pointe noire à tête rotative; utilisez-les pour placer les Tag sur un étal, piqués dans des fruits, muffins ou tout autre objet.

Grâce à ce scratch, accrochez l'ardoise Tag au mur ou sur une vitrine.



TAG-VELCRO
x5
5x5cm

Désormais, vous pouvez facilement placer les ardoises Tags sur leurs supports et les poser sur un comptoir à côté des produits (boulangeries, fleuristes, sur le marché) ou pour les buffets des hôtels afin de présenter les informations concernant le petit-déjeuner, déjeuner ou le dîner aux clients. Vous avez également la possibilité de les utiliser à souhait comme numéros de table ou étiquettes pour les noms des invités !



ACRYLIC

Les ardoises de table acrylique sont faciles à utiliser pour toutes vos communications. Placez-les sur un comptoir à côté des produits (boulangeries, fleuristes, sur le marché) ou pour les buffets des hôtels afin de présenter les informations concernant le petit-déjeuner, déjeuner ou le dîner aux clients.

Nouveau

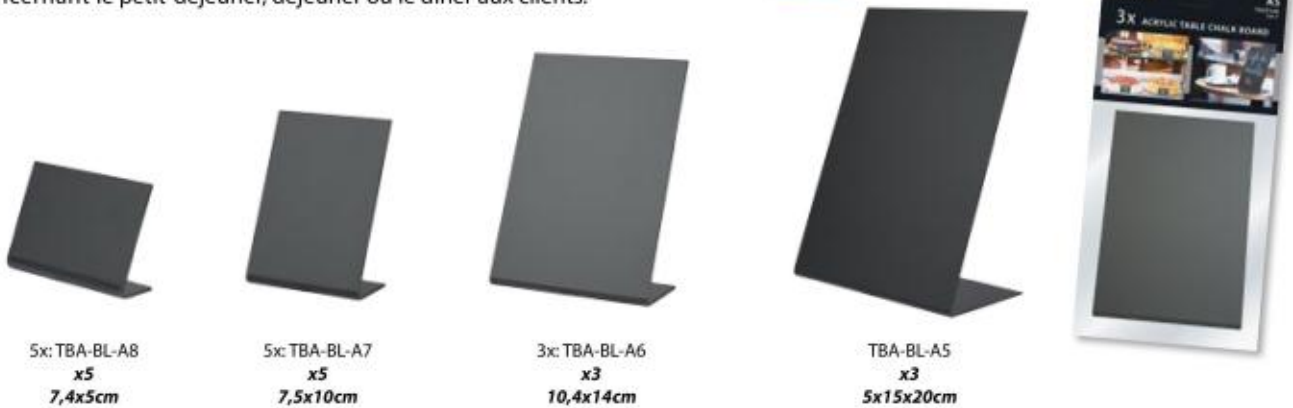

5x: TBA-BL-A8
x5
7,4x5cm

5x: TBA-BL-A7
x5
7,5x10cm

3x: TBA-BL-A6
x3
10,4x14cm

TBA-BL-A5
x3
5x15x20cm



CHEVALETS DE TABLE

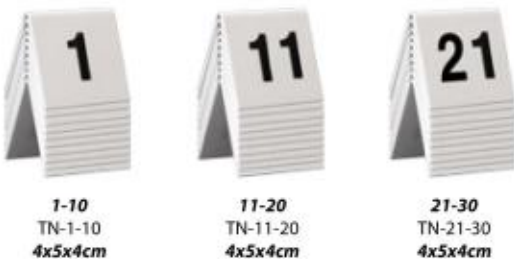

1-10
TN-1-10
4x5x4cm

11-20
TN-11-20
4x5x4cm

21-30
TN-21-30
4x5x4cm

Outil indispensable des restaurants à succès, ces petits chevalets de table empilables et faciles à nettoyer sont imprimés en noir sur blanc, pour une vision claire. Chevalet «Réservé» par lot de 5, numéros de table par dizaine.



31-40
TN-31-40
4x5x4cm

41-50
TN-41-50
4x5x4cm

51-60
TN-51-60
4x5x4cm



<i>Reserved</i>	<i>Réservé</i>	<i>Reserviert</i>	<i>Riservato</i>	<i>Reservado</i>	<i>Gereserveerd</i>
TN-RES-EN	TN-RES-FR	TN-RES-DE	TN-RES-IT	TN-RES-ES	TN-RES-NL
10x5x4cm	10x5x4cm	10x5x4cm	10x5x4cm	10x5x4cm	10x5x4cm
x5	x5	x5	x5	x5	x5





PANCARTE SILHOUETTE



FBS-RECTANGLE
73x50cm



FBS-ARROW
73x45cm



NOUVEAU : grâce à cette signalétique de formes différentes, vous pouvez facilement informer les clients, quelque soit l'endroit! Base en bois et un feutre-craie Securit® à encre liquide coloris blanc inclus. Deux formes disponibles.

+







SILHOUETTE



Nouveau



FB-BUBBLE
47x32cm



FB-GLASS
50x23cm



FB-OVAL
38x30cm



FB-BOTTLE
50x19cm



+



FB-CUP
44x29cm



FB-CLOUD
48x29cm



FB-FISH
49x30cm

Cette ligne d'ardoises «Silhouette» comprend 10 formes différentes, chacune d'elle est livrée avec un feutre craie blanc mais, elles peuvent aussi être utilisées avec tous nos feutres-craies, essayez les 10 couleurs que nous vous proposons et laissez libre cours à votre créativité! Un feutre-craie à encre liquide Securit® et un kit scratch pour accrocher au mur inclus.



FB-FLOWER
43x39cm



FB-CHICKEN
36x29cm



FB-FOURLEAF
32x29cm





UNIVERSELLES



*Meilleure
qualité*

Large gamme d'ardoises rectangulaires à la fois modernes et fonctionnelles. Elles apporteront une note de raffinement à votre établissement, tout en constituant un support informatif et décoratif. Notre gamme est déclinée en 5 lignes : teck, nature, acajou, wengé et noir, allant de 4 à 6 formats différents. Ces ardoises murales sont réversibles et peuvent être utilisées avec les chevalets 65 cm et 165 cm. Prévu pour un usage intérieur et extérieur. Ces ardoises sont en bois dur et sont résistantes aux rayures, aux UV et aux déformations dues à la chaleur. Deux petits crochets sont fournis pour accrocher les ardoises à l'aide d'une cordelette (non incluse).



Acajou

WBU-M-30	30x40cm
WBU-M-40	40x50cm
WBU-M-50	50x60cm
WBU-M-60	60x80cm
WBU-M-70	70x90cm
WBU-M-80	80x100cm



Nature

WBU-B-30	30x40cm
WBU-B-40	40x50cm
WBU-B-50	50x60cm
WBU-B-60	60x80cm
WBU-B-70	70x90cm
WBU-B-80	80x100cm



Teck

WBU-TE-30	30x40cm
WBU-TE-40	40x50cm
WBU-TE-50	50x60cm
WBU-TE-60	60x80cm
WBU-TE-70	70x90cm



Wengé

WBU-DB-30	30x40cm
WBU-DB-40	40x50cm
WBU-DB-50	50x60cm
WBU-DB-60	60x80cm
WBU-DB-70	70x90cm



Noir

WBU-BL-40	40x50cm
WBU-BL-60	60x80cm
WBU-BL-70	70x90cm



DORÉES



WBC-G-105
75x105 cm



WBC-G-85
65x85 cm



Ardoises murales avec cadre doré décoratives pour apporter une touche luxueuse et moderne. Prévues pour une utilisation en intérieur. Ces ardoises sont en bois dur et sont résistantes aux rayures, aux UV et aux déformations dues à la chaleur. A utiliser avec les feutres-craies Securit® (non inclus).



LONGUES



Ardoises longues à poser verticalement ou horizontalement. Elles sont faciles à accrocher et dotées d'un design élégant. Disponible dans la gamme wengé et teck, en 4 formats 100x56cm, 120x56cm, 150x56cm, 170x56cm. Cadre bois réversible avec double surface d'écriture. Ces ardoises sont en bois dur et sont résistantes aux rayures, aux UV et aux déformations dues à la chaleur. Deux petits crochets sont fournis pour accrocher les ardoises à l'aide d'une cordelette (non incluse). A utiliser avec les feutres-craies Securit® (non inclus).



Teck

WBL-TE-100 **100x56cm**
 WBL-TE-120 **120x56cm**
 WBL-TE-150 **150x56cm**
 WBL-TE-170 **170x56cm**



Wengé

WBL-DB-100 **100x56cm**
 WBL-DB-120 **120x56cm**
 WBL-DB-150 **150x56cm**
 WBL-DB-170 **170x56cm**





WOODY



Noir

WBW-BL-20-24	20x24 cm
WBW-BL-20-40	20x40 cm
WBW-BL-30-40	30x40 cm
WBW-BL-40-60	40x60 cm
WBW-BL-60-80	60x80 cm



Teck

WBW-TE-20-24	20x24 cm
WBW-TE-20-40	20x40 cm
WBW-TE-30-40	30x40 cm
WBW-TE-40-60	40x60 cm
WBW-TE-60-80	60x80 cm

Meilleur prix



La qualité à petit prix! Ces ardoises murales avec un cadre en bois sont faciles à nettoyer et résistantes aux rayures, aux UV et aux déformations dues à la chaleur. Disponible en différents coloris: noir laqué, teck laqué, hêtre laqué ou finition acajou laqué. Un feutre-craie à encre liquide de coloris blanc (lavable) et le kit de montage sont inclus.





PANNEAUX FLASHY LED



LB-DB-40
40x50cm
20 LEDs

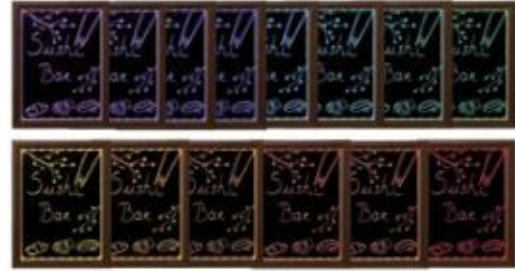

LB-DB-56
56x70cm
40 LEDs

Panneaux flashy LED disponibles en 3 formats 40x50 cm, 56x70 cm et 62x100 cm. Ces panneaux muraux disposent de 5 programmes lumineux, 10 programmes de réglage et d'intensité, 16 couleurs et sont livrés avec une télécommande. Ce présentoir à affichage fluo LED est idéal pour créer une ambiance conviviale et chaleureuse dans votre établissement. Il s'utilise avec des feutres-craies et il est prévu uniquement pour un usage intérieur. Il peut être branché sur secteur et utilisé avec une batterie Securit® (non incluse). Télécommande et un feutre-craie inclus.



LB-DB-62
62x100cm
60 LEDs



MENU

SALADS
Ham - Cheese - Tuna -
Egg - Crab or Tomato

BURGERS
Beef - Cheese - bacon
fish - chicken - Sate

FILLINGS
Baked beans, cheese -
Chili con carne, Bolognese

Ice creams

- Strawberry 
- Pear 
- Chocolat 
- Vanilla 
- lemon 
- Orange 
- Mint 
- Cherry 
- Apple 
- Mango 





MULTI BOARD



Nouveau



Gris métallisé
SBM-SS-115
60x115cm



Noir
SBM-BL-115
60x115cm



Blanc
SBM-WT-115
60x115cm

Multi-ardoises Securit®. Connectez et divisez les ardoises en autant de parties que vous le souhaitez pour créer votre propre panneau ardoise.

Réalisez un triangle autour d'un arbre, utilisez-la en guise de panneau trottoir, de séparation sur une terrasse ou accrochez-les au mur.

Il est même possible de les disposer à l'angle d'un bâtiment. Les possibilités sont infinies! Pack simple, comprend 2 charnières et 2 protections de pieds en caoutchouc.

A utiliser avec les feutres-craies à encre liquide Securit® (non inclus).

Socle multi-ardoises Securit® (2 pieds) vendu séparément.

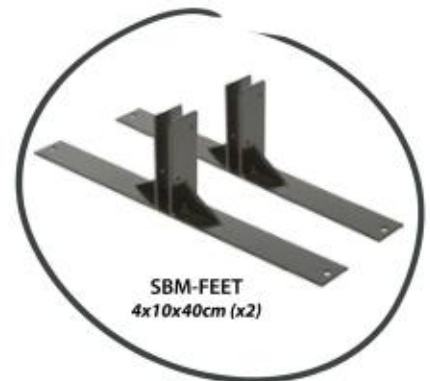

SBM-Feet
4x10x40cm (x2)



Ces panneaux trottoir sont composés de deux ardoises de qualité supérieure reliées par une chaîne. Ils vous permettront de présenter les informations essentielles du moment à vos clients. Prévus pour un usage intérieur et extérieur grâce à une triple couche de vernis de protection. Conçus pour une utilisation avec les feutres-craies Securit®. Ces panneaux sont en bois dur et sont résistants aux rayures, aux UV et aux déformations dues à la chaleur.



Meilleure qualité



Acajou
SDT-M-120
120x55cm
10 KG



Nature
SDT-B-120
120x55cm
10 KG



Wengé
SBD-DB-85
85X55cm
9 KG



Teck
SBD-TE-85
85X55cm
9 KG



Acajou
SBD-M-85
85X55cm
9 KG



Nature
SBS-B-85
85X55cm
9 KG



Wengé
SBS-DB-120
120x70cm
16 KG



Teck
SBS-TE-120
120x70cm
16 KG



Acajou
SBS-M-135
138x70cm
17 KG



Nature
SBS-B-135
138x70cm
17 KG





WOODY



*Meilleur
prix*

Ces panneaux trottoirs sont fabriqués en pin, ils sont prévus pour un usage en intérieur et en extérieur grâce à une triple couche de vernis de protection. Faciles à nettoyer, résistants aux rayures, aux UV et aux déformations dues à la chaleur. Conçus pour une utilisation avec les feutres-craies Securit®.



Noir
SBD-BL-85
85X55cm
4KG



Teck
SBDW-TE-85
85X55cm
4KG



Noir
SBS-BL-120
125X70cm
8KG



Teck
SBSW-TE-120
125X70cm
8KG



Acajou
SBSW-M-120
125X70cm
8KG



CHEVALETS

Chevalet en bois dur à placer dans l'entrée, à l'intérieur ou à l'extérieur de votre établissement. Vous pourrez désormais informer facilement vos clients, et ce de manière élégante, pratique et attractive.



Noir
EZL-BL-165
165cm



Wengé
EZL-DB-165
165cm



Acajou
EZL-M-165
165cm



Teck
EZL-TE-165
165cm



Nature
EZL-B-165
165cm

MONO



Acajou
MBS-M-85
55x85cm



Chevalet à trois pieds, à placer en intérieur ou extérieur. Dimensions 55 x 85 cm. Les panneaux sont en bois dur et sont résistants aux rayures, aux UV et aux déformations dues à la chaleur.





COULEURS NATURE



Nouveau



2-6mm

●●●●●● SMA510-V8-ET



7-15mm

●●●●●● SMA720-V8-ET



Le feutre-craie à encre liquide Securit® est idéal pour décorer vos ardoises. Customisez-les à volonté grâce au nettoyage facile des inscriptions au feutre-craie. Secouez, appuyez, écrivez et laissez sécher quelques minutes!

NOUVEAU: les feutres-craies à encre liquide Securit® couleurs Nature.



BLISTERS



1-2mm

- ● ● ○ BL-SMA100-V4-COL
- ● ● ○ BL-SMA100-V4-TRO
- ○ ○ ○ BL-SMA100-V4-WT



1-2mm

- ● ● ● ● ○ BL-SMA100-V7-AS
- ○ ○ ○ ○ ○ BL-SMA100-V7-WT



2x 1-2mm + 2x 2-6mm + 7-15mm

- ○ ○ ○ BL-SMAMIX-V5-WT



2-6mm

- ○ BL-SMA510-WT
- ● BL-SMA510-BU
- ● BL-SMA510-OR
- ● BL-SMA510-VT
- ● BL-SMA510-PI
- ● BL-SMA510-RD
- ● BL-SMA510-GR
- ● BL-SMA510-YE
- ● (or) BL-SMA510-GD
- ● (argent) BL-SMA510-SL



7-15mm

- BL-SMA720-WT
- BL-SMA720-BU
- BL-SMA720-OR
- BL-SMA720-VT
- BL-SMA720-PI
- BL-SMA720-RD
- BL-SMA720-GR
- BL-SMA720-YE

Feutres de qualité vendus à l'unité ou par lot. Ils donneront un aspect artistique et créatif à vos supports. Disponible en 3 tailles : petit, moyen et grand format pour s'adapter à tous vos besoins et idées.

Ces feutres-craies à encre liquide sont munis d'un système de valve qui permet à la pointe de ne jamais s'assécher. Effaçable à l'aide d'un chiffon humide ou à l'aide du spray Securit® spécialement conçu à cet effet. Utilisation prévue pour : ardoise murale, panneau trottoir, vitrine, miroir, plastique, métal, verre, ardoise et toutes les autres surfaces non poreuses.

ÉTUIS



À L'UNITÉ



ACCESSOIRES POUR FEUTRES-CRAIES

Flacon spray nettoyant pour feutres-craies, spécialement conçu pour nettoyer vos supports comme les ardoises murales, les chevalets de table ou les panneaux trottoir.

Nouveau: L'éponge magique Securit® rénove tous les tableaux noirs et nettoie les inscriptions au feutre-craie à encre liquide.



SECSTEN-5
500ml

Set de 5 pochoirs avec lettres, chiffres, signes, pictogrammes. Idéal pour donner un effet uniforme et professionnel à vos supports. Facile et pratique, ces pochoirs vous feront gagner un temps précieux.



LIGNE CLASSIQUE



MC-CRBP-BL
13x23cm

Porte addition



MC-CRWC-BL
A4: 24x34cm

Catre des vins



MC-CR45-BL
A45: 18x36cm



NOIR

MC-CRA5-BL
A5: 18x25cm



MC-CRA4-BL
A4: 24x34cm



MC-BOX-CRA4-BL
20x A4: 37x29x21cm

Box menus



MC-CR45-WR
A45: 18x36cm



BORDEAUX

MC-CRA5-WR
A5: 18x25cm



MC-CRA4-WR
A4: 24x34cm



MC-BOX-CRA4-WR
20x A4: 37x29x21cm

Protège-menus de la gamme Classique en simili cuir, disponibles en format A4 et A5 ou en modèle long de couleur noir et rouge. Protège-menus équipés de coins renforcés et de caractères italiques de couleur dorée. Ils possèdent un double insert amovible et sont en simili cuir, faciles à nettoyer à l'aide d'un chiffon humide.

Carte des vins de couleur noir au format A4. Cette carte des vins possède 2 doubles inserts. (8 pages).

Porte addition fonctionnel et élégant de couleurs noir (23 x 13 cm). Il possède un design simple et efficace pour y présenter vos additions.

Box menus, elles comprennent chacune 20 menus de format A4.

MARRON CLAIR



MC-CRA5-BR
A5: 18x25cm



MC-CRA4-BR
A4: 24x34cm



MC-BOX-CRA4-BR
20x A4: 37x29x21cm

BEIGE



MC-CRA5-BI
A5: 18x25cm



MC-CRA4-BI
A4: 24x34cm



MC-BOX-CRA4-BI
20x A4: 37x29x21cm



Inserts en polypropylène. Ne laissent pas de traces fantômes de vos menus. Vendus par set de 10 pièces.

A4 MC-TI-A4
A5 MC-TI-A5
A45 MC-TI-A45





Avec son design audacieux et original, la gamme Rio vous propose des menus de qualité et fabriqués dans le respect de l'environnement. Sa couverture en plastique PP à rayures et sa large plaque «menu» en acier brossé en font une collection originale et robuste. Plaque en acier brossé «menu» ou avec fourchette, couteau et cuillère sur la couverture. Aussi disponible: Carte des vins de la gamme Rio. Les cartes menus Rio sont protégées contre les UV, les rayures ainsi que les taches, facilitant leur entretien. Insérez aisément jusqu'à 10 inserts Securit® transparents grâce à un élastique résistant situé au centre des cartes. Chaque menu est livré avec un double insert pouvant contenir 4 feuilles de format A4. Des inserts Securit® supplémentaires sont disponibles à part.

	25x34 cm MC-RCA4-BL	MC-RCA4-OR	MC-RCA4-RD	MC-RCA4-VT	MC-RCA4-GR	MC-RCA4-BU	MC-RCA4-WT
	25x34 cm MC-RCA4-BL-FK	MC-RCA4-OR-FK	MC-RCA4-RD-FK	MC-RCA4-VT-FK	MC-RCA4-GR-FK	MC-RCA4-BU-FK	MC-RCA4-WT-FK
	25x34 cm MC-RCWC-BL						





20x A4: 37x29x21cm
MC-BOX-TRA4-BL

Box menus



A4: 24x34cm
MC-TRWC-BL

Carte des vins



13x23cm
MC-TRBP-BL

Porte addition



NOIR
A5: 18x25cm
MC-TRA5-BL



A45: 18x34cm
MC-TR45-BL



A4: 24x34cm
MC-TRA4-BL

Protège-menus Tendance aux couleurs modernes et originales de format A4 et A5. Également disponibles en modèle long de couleur noire, brun clair et bordeaux. Les protège-menus possèdent 1 double insert amovible et la carte des vins 2 doubles inserts. Matière simili cuir facile à nettoyer à l'aide d'un chiffon humide.

Porte addition Tendance : Comprend des emplacements pour cartes de crédit, argent comptant et factures.

Box menus en matière simili cuir facile à nettoyer à l'aide d'un chiffon humide. Elles comprennent chacune 20 menus de format A4.



BLEU
A5: 18x25cm
MC-TRA5-BU



A45: 18x34cm
MC-TR45-BU



A4: 24x34cm
MC-TRA4-BU



VERT
A5: 18x25cm
MC-TRA5-GR



A45: 18x34cm
MC-TR45-GR



A4: 24x34cm
MC-TRA4-GR



Inserts en polypropylène. Ne laissent pas de traces fantômes de vos menus
Vendus par set de 10 pièces.

- A4 MC-TI-A4
- A5 MC-TI-A5
- A45 MC-TI-A45



20x A4: 37x29x21cm
MC-BOX-TRA4-LB



20x A4: 37x29x21cm
MC-BOX-TRA4-GR



MARRON CLAIR
A5: 18x25cm
MC-TRA5-LB



A45: 18x34cm
MC-TR45-LB



A4: 24x34cm
MC-TRA4-LB



20x A4: 37x29x21cm
MC-BOX-TRA4-WR



20x A4: 37x29x21cm
MC-BOX-TRA4-BU



BORDEAUX
A5: 18x25cm
MC-TRA5-WR



A45: 18x34cm
MC-TR45-WR



A4: 24x34cm
MC-TRA4-WR

Best seller



LIGNE BASIQUE



MC-BRA5-WR
A5: 18x25cm

MC-BRA4-WR
A4: 24x34cm



MC-BRA5-BL
A5: 18x25cm

MC-BRA4-BL
A4: 24x34cm



Carte des vins
MC-BRWC-BL
A4: 24x34cm



Porte addition
MC-BRBP-BL
13x23cm

Protège-menus au design simple et neutre qui s'accordera aisément avec le style de votre établissement. La gamme basique 1er prix en PVC comprend 2 inserts intégrés à la face intérieure de la couverture ainsi que 4 inserts transparents non amovibles. Le tout permettant de présenter 10 vues. Il n'est pas possible d'ajouter des inserts supplémentaires. Les menus sont munis de coins métalliques et de pictogrammes de couleur dorée.

Carte des vins, 6 inserts fixes inclus (10 pages)

Porte addition, comprend des emplacements pour cartes de crédit, argent comptant et factures.

LIGNE BOIS



MC-BOX-WRA4-BL
Box 20xA4: 37x29x21cm



MC-WRA4-BL A4: 26x32cm
MC-WRA5-BL A5: 21x24cm

Protège-menus de la ligne bois avec 2 inserts munis de deux coins métalliques (4 pages). Disponible en format A4 et A5. Doté d'une baguette en bois permettant de placer des inserts grâce à des petites vis de couleur dorée.

Inserts double face aussi vendus séparément par lots de 5. Chaque insert est équipé de 2 coins métalliques de couleur dorée.

Box menus contient 20 protège-menus bois A4 (2 inserts dans chaque menu présentant 4 pages).



MC-WIA4-BL
5x Insert A4: 26x32cm



MC-WIA5-BL
5x Insert A5: 21x24cm



Marron



Bordeaux



Vert



Bleu



Beige

	A5	MC-WRA5-BR	MC-WRA5-WR	MC-WRA5-GR	MC-WRA5-BU	MC-WRA5-BI
	A4	MC-WRA4-BR	MC-WRA4-WR	MC-WRA4-GR	MC-WRA4-BU	MC-WRA4-BI
20xA4	Box	MC-BOX-WRA4-BR	MC-BOX-WRA4-WR	MC-BOX-WRA4-GR	MC-BOX-WRA4-BU	MC-BOX-WRA4-BI
5x	Insert A5	MC-WIA5-BR	MC-WIA5-WR	MC-WIA5-GR	MC-WIA5-BU	MC-WIA5-BI
5x	Insert A4	MC-WIA4-BR	MC-WIA4-WR	MC-WIA4-GR	MC-WIA4-BU	MC-WIA4-BI

LIGNE CRISTAL



● A4: 22x31cm MC3-CYA4-BR1



● A4: 22x31cm MC3-CYA4-BR2



● A4: 22x31cm MC3-CYA4-BR3

Protège-menus transparents, anti-reflet, double-face, facile à nettoyer, simili cuir, bords cousus et coins de protection métalliques. Disponible en 3 formats :

- Set de 3 formats: set de 3 protège-menus simples avec coins métalliques 2 pages
- Set de 3 protège-menus doubles avec coins métalliques et 4 pages
- Set de 3 protège-menus triples avec coins métalliques et 6 pages, disposant de 4 coins métalliques couleur chrome.





Cork
MC-DRA4-CORK
A4: 24x34cm

Carte des vins
MC-DRWC-CORK
A4: 24x34cm



Cork box
MC-BOX-DRA4-CORK
10xA4: 37x29x21cm

box carte des vins
MC-BOX-DRWC-CORK
10xA4: 37x29x21cm



Paisley
MC-DRA4-PAISLEY
A4: 24x34cm



Paisley box
MC-BOX-DRA4-PAISLEY
20xA4: 37x29x21cm

Protège-menus originaux et luxueux de la gamme Design. Découvrez les 6 thèmes proposés. Du croco aux matières naturelles, du décontracté au sophistiqué, trouvez le style qui vous correspond ! Ces protège-menus A4 sont dotés d'un double insert amovible qui présente 4 pages.

La **carte des vins** de la gamme liège (cork) est également disponible au format A4.



Menu
MC-TRA4-WT
A4: 24x34cm



Vins
MC-TRWC-WT
A45: 18x34cm



Boissons
MC-TRBC-WT
A45: 18x34cm



Velour
MC-DRA4-VELVET
A4: 24x34cm



Carte des vins velour
MC-DRWC-VELVET
A4: 24x34cm



Croc
MC-DRA4-CROC
A4: 24x34cm



Croc
MC-DR45-CROC
A4: 20x34cm



Croc
MC-DR45-CROC3
A45: 20x34cm



Dune
MC-DRA4-DUNE
A4: 24x34cm



Reptile
MC-DRA4-REPTILE
A4: 24x34cm



Summer
MC-DRA4-SUMMER
A4: 24x34cm



Vogue
MC-DRA4-VOGUE
A4: 24x34cm



Wood
MC-DRA4-WOOD
A4: 24x34cm



Video:





LIGNE LED

CUIVRE



2xA4: 27x35cm

- MC-LDA4-CP
- MC-LDA4-SL
- MC-LDA4-BL

ARGENT



2xA45: 20x35cm

- MC-LD45-CP
- MC-LD45-SL
- MC-LD45-BL

NOIR



1xA4: 27x35cm

- MC-LDSP-CP
- MC-LDSP-SL
- MC-LDSP-BL

En Simili cuir, sa surface est imprimable et facile d'entretien. Éclairage LED blanc (durée de vie jusqu'à 50.000h) soit une durée d'autonomie jusqu'à 500 ouvertures/fermetures - avec éclairage progressif à l'ouverture de la carte-menu. La carte menu simple possède une page A4 avec éclairage instantané activé grâce à une pression sur le bouton situé en bas à gauche du support menu (bouton on/off).

- Résistant aux chocs, aux rayures, anti-taches
- Batterie lithium ion rechargeable intégrée
- Importante durée d'autonomie (=/- 2 semaines)
- Câble de recharge USB inclus
- Se recharge facilement, 3h en moyenne
- Garantie 1 an



MC-LD-MC10
10xUSB



inserts transparents

20xA4Jet d'encre MC-LIA4-IJ
20xA4Laser MC-LIA4-LJ



VENTOUSES



A4 : 27x36 cm PFW-A4-BL
A3 : 39x52 cm PFW-A3-BL



A4 : 27x36 cm PFW-A4-RD
A3 : 39x52 cm PFW-A3-RD



A4 : 27x36 cm PFW-A4-YE
A3 : 39x52 cm PFW-A3-YE



A4 : 27x36 cm PFW-A4-GY
A3 : 39x52 cm PFW-A3-GY

Porte-affiche équipé de 4 ventouses, facile à fixer sur une vitre. Se nettoie facilement. Recto verso, il peut être vu de l'extérieur mais aussi de l'intérieur de l'établissement. Ouverture latérale spécialement conçue pour insérer régulièrement vos horaires d'ouvertures, vos promotions du moment, vos événements et vos menus. Résistant à la chaleur et aux UV.



DE TABLE

Idéales pour les collectivités, ces porte affiches de table dans la gamme vernis couleur teck, disponible en deux formats : A4, A5. Vous pourrez y insérer un document ou une affiche.



Teck

A4: 5x15x17cm PFT-TE-SM
A5: 6x20x23cm PFT-TE-ME
A6: 7x27x32cm PFT-TE-LA



Nero

A6: 5x15x17cm PFT-BL-SM
A5: 6x20x23cm PFT-BL-ME
A4: 7x27x32cm PFT-BL-LA







GRIS MÉTALLISÉ



La gamme de porte-menus éclairés LED, gris métallisé est prévue pour une utilisation durable et consomme très peu d'énergie. Ce modèle de porte-menu s'inscrit dans une démarche de développement durable grâce aux LED basse consommation. Nos porte-menus faciliteront la communication et impacteront l'image de votre établissement. Il peut être branché sur secteur et utilisé avec 2 batteries Securit® (non inclus). Prévu pour un usage en intérieur et en extérieur, ce produit est résistant à l'eau. Ces porte-menus nécessitent l'usage de 2 batteries.



MCS-BA-135
135cm
15 KG



MCS-6A4-CS
68x72cm
21 KG
48 LEDs
6xA4



MCS-BA-95
95cm
15 KG



MCS-3A4-CS
40x72cm
12 KG
48 LEDs
6xA4



MAGNET-16
16x Aimants

MCS-BATT
Batterie





INOX BROSSÉ



MCS-6A4-LSS
99x52cm
19KG
72 LEDs
6x A4



MCS-4A4-LSS
69x52cm
17 KG
48 LEDs
4x A4



MCS-BA-120
120cm
19KG



*Meilleure
qualité*

Porte-menus en inox brossé

Affichage LED avec des couleurs de très haute qualité. Il s'accordera parfaitement à votre mobilier de terrasse. Il possède des LED basse consommation. Et sa matière ne rouille pas. Ces porte-menus disposent de 5 programmes, 16 couleurs et sont livrés avec une télécommande. Ils peuvent être posés au mur ou montés sur un pied (vendu séparément). Ils peuvent être branchés sur secteur et utilisés avec 2 batteries Securit® (non incluses). Le socle est équipé de 2 roues pour une manutention aisée du produit. Prévu pour un usage intérieur et extérieur.

Pied et base en inox brossé

Cette solution vous permettra de pouvoir placer votre présentoir où vous le souhaitez. L'intérieur de la base du pied est en béton, ce qui confère une grande stabilité au produit. Le présentoir est muni de roulettes, ce qui facilite son déplacement.



MAGNET-16

16x aimants

MCS-BATT

Batterie



Video:





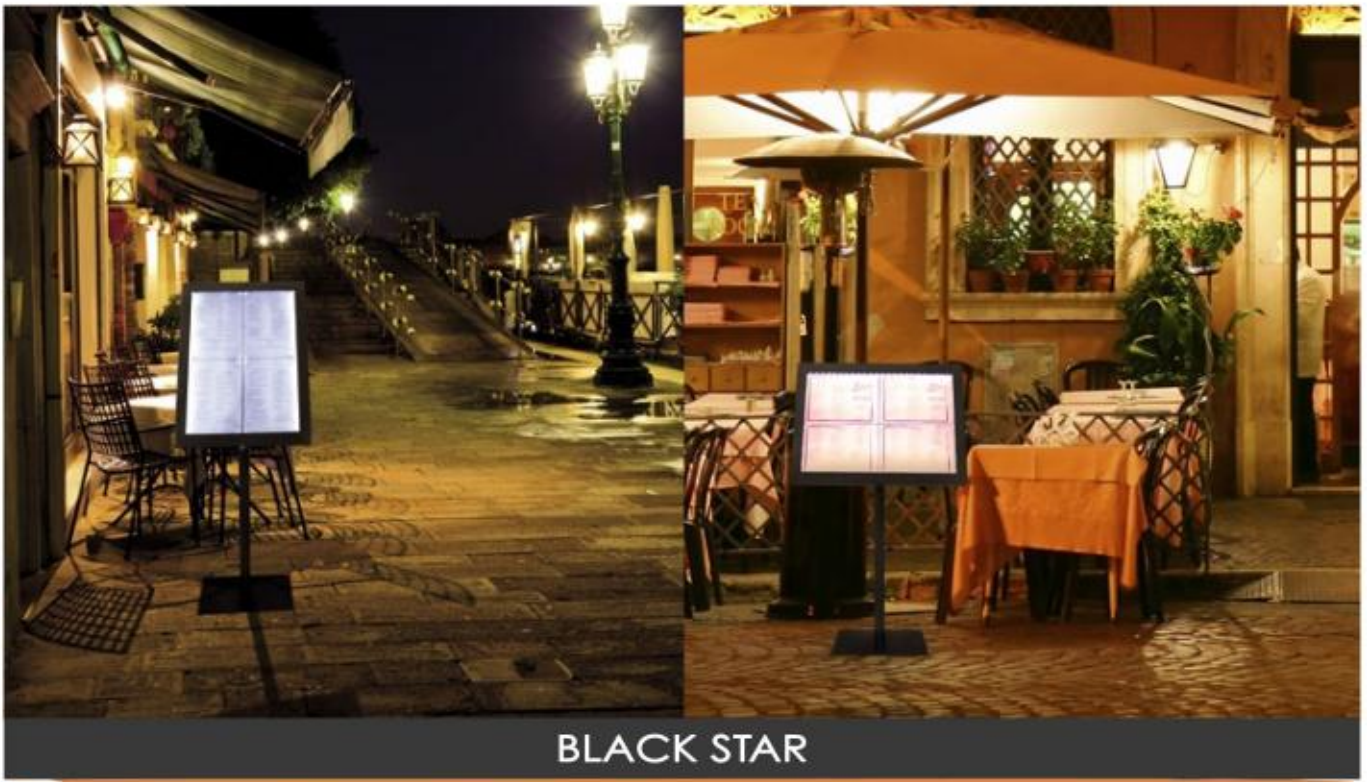

BLACK STAR

Présentoir en métal «Black star» tout en 1 (présentoir+pied+base). Affichage LED de couleur blanche. Il est équipé d'une vitre en verre sécurisé, d'une plaque en fer où vous pourrez aimanter vos menus, d'une serrure avec 2 clefs et d'un adaptateur de 5m. Il peut être utilisé en intérieur et extérieur, et branché sur secteur ou utilisé avec 1 batterie Securit® (non incluse).



Meilleur prix

MCS-4A4-BL-SET
144x50cm
20 KG
24 LEDs
4x4



MAGNET-16

16x aimants

MCS-BATT

Batterie



CLASSIC



RS-CLRP-GOWT



RS-CLRP-GOBR



RS-CLRP-GOBL



RS-CLRP-GOBU



RS-CLRP-GORD

150x4cm



RS-CLRP-CHWT



RS-CLRP-CHBR



RS-CLRP-CHBL



RS-CLRP-CHBU



RS-CLRP-CHRD



RS-CLWH-CH
21x13x4cm



RS-CLWH-GO
21x13x4cm



A4: 24x46cm
RS-SIGN-A4-PC



A4: 24x46cm
RS-SIGN-A4-PG

Poteaux d'accueil modèle or à tête ronde ou chromé à tête plate, d'une hauteur d'1m. Ils se placent idéalement à l'entrée de votre établissement ou afin de délimiter des zones d'attente. Grande stabilité grâce à leur socle de 12 kilos. Convient tant pour un usage extérieur qu'intérieur.

Les cordons pour poteaux d'accueil disponibles avec embouts chromés ou or, 1,5m de long et 38mm d'épaisseur.

Porte-affiche pour poteaux d'accueil. Vous pourrez y insérer des documents à placer entre 2 plaques de PVC ou 1 ou 2 ardoises A4.



RS-CL-GO
31x91cm
12,5kg



RS-CL-CH
31x96cm
12,5kg

RETRACTABLE

Poteaux d'accueil et accroches murales en inox brossé à corde rétractable (2,1m). Ils conviennent tant pour un usage en extérieur ou en intérieur et résistent à tous types d'intempéries.

Porte-affiche pour poteaux d'accueil. Vous pourrez y insérer des documents à placer entre 2 plaques de PVC ou 1 ou 2 ardoises A4.



RS-RT-RVS-RD
100x50 ≥ 210cm
12kg



RS-RT-RVS-BL
100x50 ≥ 210cm
12kg



RS-RT-RVS-GY
100x50 ≥ 210cm
12kg



RS-RT-BL
100x50 ≥ 210cm
12kg



RS-RT-RVS-BU
100x50 ≥ 210cm
12kg

ACCROCHE MURALE



RS-RTWM-RVS-RD
14x8 ≥ 210cm



RS-RTWM-RVS-GY
14x8 ≥ 210cm



A4: 24x46cm RS-SIGN-A4-PS







CENDRIERS EXTÉRIEURS

Cendrier mural en inox brossé de 53 cm. Ce cendrier possède un design sobre et élégant. Il est très facile à fixer sur tous types de murs. Le kit de fixation est inclus.

Cendrier sur pied en inox d'une hauteur de 100cm. Son pied bénéficie d'une grande stabilité et il résiste à tous types d'intempéries grâce à un socle lourd.



Modèle mural
SP-SS-WM
51x11x6cm



Modèle sur pied
SP-SS-SM-SET
100x31cm

Nouveau



Modèle sur pied
SP-BL-SM-SET
100x31cm