

griglia

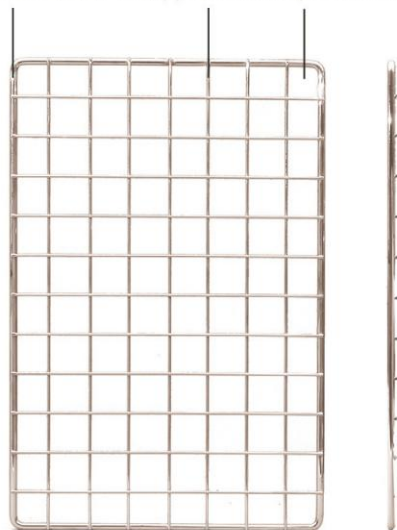

Pannelli con cornice filo semplice / Panel with single wire frame Panneaux avec cadre à un seul fil / Решетки с одинарной рамкой

filo/труба Ø 10 мм filo/труба Ø 4 мм quadro/секция 50x50 мм



Filo cornice: Ø 10 mm
Filo maglia : Ø 4 mm
Quadro maglia 50x50 mm
Frame wire: Ø 10 mm
Mesh wire: Ø 4 mm
Mesh panel 50x50 mm
Fil cadre: Ø 10 mm
Fil maillon: Ø 4 mm
Panneau maillon 50x50 mm
Труба рамки: Ø 10 мм
Труба решетки: Ø 4 мм
Секция решетки: 50x50 мм

Pannelli con cornice filo doppio / Panel with double wire frame Panneaux avec cadre à un fil double / Решетки с двойной рамкой

filo/труба Ø 6 мм filo/труба Ø 4 мм quadro/секция 50x50 мм

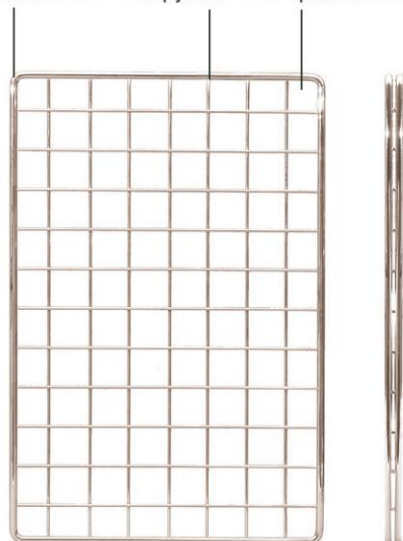

Filo cornice: doppio filo Ø 6 mm
Filo maglia : Ø 4 mm
Quadro maglia 50x50 mm
Frame wire: double wire Ø 6 mm
Mesh wire: Ø 4 mm
Mesh panel 50x50 mm
Fil cadre double: Ø 6 mm
Fil maillon : Ø 4 mm
Panneau maillon 50x50 mm
Труба рамки: двойная труба Ø 6 мм
Труба решетки: Ø 4 мм
Секция решетки: 50x50 мм

(QUANTITA' MINIMA D'ORDINE
PER MISURA 50 PZ.)
(MINIMUM ORDER QUANTITY
FOR SIZE 50 PCS)
(QUANTITE' POUR UNE COMMANDE PAR
DIMENSION 50 PCS)
(МИНИМАЛЬНОЕ КОЛИЧЕСТВО ЗАКАЗА
РЕШЕТОК ОДНОГО ВИДА: 50 ШТ.)



6000 / 6001 / 6002 / 6003

Pannello griglia maglia 50x50 mm, cornice filo semplice.
 Grill rack with 50x50 mm mesh and single wire frame.
 Panneau en grille avec maillon 50x50 mm et cadre à fil simple.
 Решетка 50x50 мм с одинарной рамой.



	6000		6001		6002		6003	
 mm	h = 2000 a = 800		h = 2000 a = 600		h = 2000 a = 400		h = 1500 a = 800	
	17,9		14,4		11		13,8	
	2		2		2		2	
	CR	V	CR	V	CR	V	CR	V

6004 / 6005 / 6006 / 6007

Pannello griglia maglia 50x50 mm, cornice filo semplice.
 Grill rack with 50x50 mm mesh and single wire frame.
 Panneau en grille avec maillon 50x50 mm et cadre à fil simple.
 Решетка 50x50 мм с одинарной рамой.



	6004		6005		6006		6007	
 mm	h = 1500 a = 600		h = 1500 a = 400		h = 1000 a = 800		h = 1000 a = 600	
	11,2		8,6		9,7		7,9	
	2		2		2		2	
	CR	V	CR	V	CR	V	CR	V

6008 / 6009 / 6010 / 6011

Pannello griglia maglia 50x50 mm, cornice filo semplice.
 Grill rack with 50x50 mm mesh and single wire frame.
 Panneau en grille avec maillon 50x50 mm et cadre à fil simple.
 Решетка 50x50 мм с одинарной рамой.

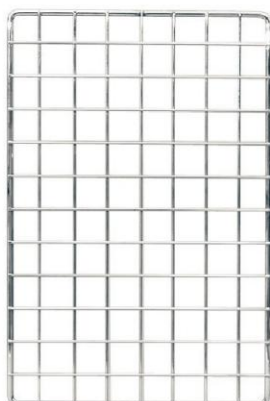

	6008		6009		6010		6011	
 mm	h = 1000 a = 400		h = 800 a = 400		h = 600 a = 600		h = 400 a = 400	
	5,90		4,90		5,40		2,80	
	2		2		2		2	
	CR	V	CR	V	CR	V	CR	V

**6000A / 6001A / 6002A / 6003A**

Pannello griglia maglia 50x50 mm, cornice filo doppio.
Grill rack with 50x50 mm mesh and double wire frame.
Panneau en grille avec maillon 50x50 mm et cadre à fil double.
Решетка 50x50 мм с двойной рамой.

	6000A	6001A	6002A	6003A
 mm	h = 2000 a = 800	h = 2000 a = 600	h = 2000 a = 400	h = 1500 a = 800
	15,40	12,10	9,20	11,90
	2	2	2	2
	CR V	CR V	CR V	CR V

**6004A / 6005A / 6006A / 6007A**

Pannello griglia maglia 50x50 mm, cornice filo doppio.
Grill rack with 50x50 mm mesh and double wire frame.
Panneau en grille avec maillon 50x50 mm et cadre à fil double.
Решетка 50x50 мм с двойной рамой.

	6004A	6005A	6006A	6007A
 mm	h = 1500 a = 600	h = 1500 a = 400	h = 1000 a = 800	h = 1000 a = 600
	9,40	7,70	7,50	6,70
	2	2	2	2
	CR V	CR V	CR V	CR V

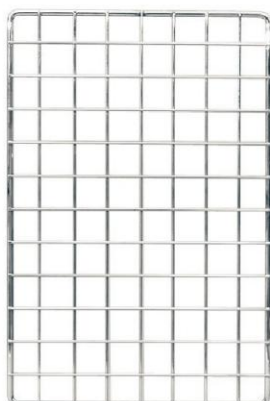
**6008A / 6009A / 6010A / 6011A**





Pannello griglia maglia 50x50 mm, cornice filo doppio.
Grill rack with 50x50 mm mesh and double wire frame.
Panneau en grille avec maillon 50x50 mm et cadre à fil double.
Решетка 50x50 мм с двойной рамой.

	6008A	6009A	6010A	6011A
 mm	h = 1000 a = 400	h = 800 a = 400	h = 600 a = 600	h = 400 a = 400
	4,90	4,00	4,50	2,40
	2	2	2	2
	CR V	CR V	CR V	CR V



6012 / 6013



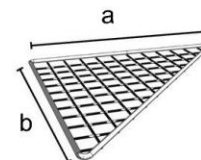

Pannello griglia triangolare maglia 50x50 mm, cornice filo semplice.
 Triangular wire rack with single wire frame 50x50 mm.
 Panneau triangulaire en grille avec maillon 50x50 mm et cadre à fil simple.
 Решетка треугольная 50x50 мм, с одинарной рамой.

	6012		6013	
 mm	a = 600 b = 600		a = 400 b = 400	
 Kg	3,90		2,20	
 Pcs/m ²	2		2	
	CR	V	CR	V



6014 / 6015



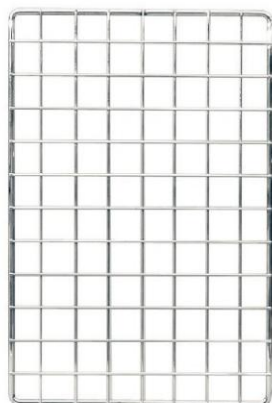
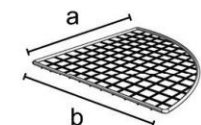

Pannello griglia settore circolare maglia 50x50 mm, cornice filo semplice.
 Circular grill rack with 50x50 mm mesh and single wire frame.
 Panneau en grille circulaire avec maillon 50x50 mm et cadre à fil simple.
 Решетка в виде сектора 50x50 мм, с одинарной рамой.

	6014		6015	
 mm	a = 600 b = 600		a = 400 b = 400	
 Kg	4,40		2,40	
 Pcs/m ²	2		2	
	CR	V	CR	V



6016 / 6017

Pannello griglia maglia 50x50 mm, cornice filo semplice.
 Grill rack with 50x50 mm mesh and single wire frame.
 Panneau en grille avec maillon 50x50 mm et cadre à fil simple.
 Решетка 50x50 мм с одинарной рамой.

	6016		6017	
 mm	h = 1500 a = 1000		h = 1000 a = 1000	
 Kg	16,20		11,40	
 Pcs/m ²	2		2	
	CR	V	CR	V

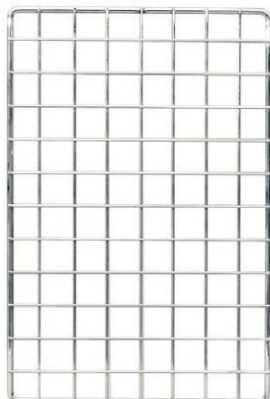

6053 / 6054 / 6055 / 6056

Pannello griglia maglia 50x50 mm, cornice filo semplice.
Grill rack with 50x50 mm mesh and single wire frame.
Panneau en grille avec maillon 50x50 mm et cadre à fil simple.
Решетка 50x50 мм с одинарной рамой.

	6053		6054		6055		6056	
 mm	h = 2000 a = 1000		h = 800 a = 800		h = 800 a = 600		h = 600 a = 400	
Kg	21,40		8,00		6,50		3,90	
Pcs/m ²	2		2		2		2	
	CR	V	CR	V	CR	V	CR	V



6053A / 6054A / 6055A / 6056A





Pannello griglia maglia 50x50 mm, cornice filo doppio.
Grill rack with 50x50 mm mesh and double wire frame.
Panneau en grille avec maillon 50x50 mm et cadre à fil double.
Решетка 50x50 мм с двойной рамой.

	6053A		6054A		6055A		6056A	
 mm	h = 2000 a = 1000		h = 800 a = 800		h = 800 a = 600		h = 600 a = 400	
Kg	18,80		7,00		5,50		4,10	
Pcs/m ²	2		2		2		2	
	CR	V	CR	V	CR	V	CR	V



6024



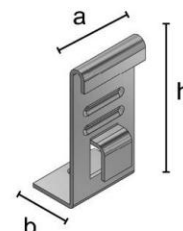

Supporto per ripiano in legno o cristallo.
Support for wooden or crystal shelves.
Support étagères en bois ou cristal.
Полкодержатель для деревянных или стеклянных полок.

6024	
	h = 77 a = 38 b = 25
	1,72
	25
	CR
	V



6025



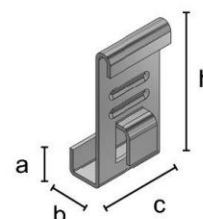

Supporto per ripiano in griglia filo semplice e doppio.
Single and double wire grill rack support.
Support étagère en grille à fil simple et double.
Полкодержатель для решетчатых полок с одинарной или двойной трубой.

6025	
	h = 75 a = 14 b = 18 c = 38
	1,63
	25
	CR
	V



6026

Giunto parallelo per griglia con cornice filo semplice e doppio.
Parallel joint for grill with single and double wire frame.
Joint parallèle pour grille avec cadre à fil simple et double.
Крепеж параллельный для решетки с рамкой одинарной или двойной.



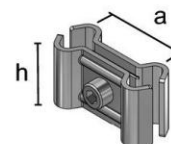

6026	
	h = 25 a = 34
	2,43
	50
	CR
	V





6027



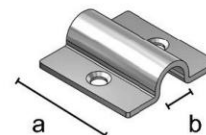

Supporto a bandiera griglia con cornice filo semplice e doppio.
Flag support for single and double wire rack.
Support à drapeau pour grille avec cadre à fil simple et double.
Держатель решетки с рамкой одинарной или двойной.

6027	
	a = 40 b = Ø 11
	1,50
	50
	CR V



6028



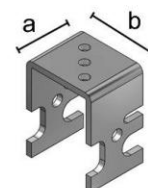

Supporto a parete per griglia con cornice filo semplice e doppio.
Wall support for single and double wire rack.
Support à paroi pour grille avec cadre à fil simple et double.
Крепление к стене для решетки с рамкой одинарной или двойной.

6028	
	a = 30 b = 37
	14,73
	200
	CR V



6029

Giunto tubo griglia con cornice filo semplice e doppio.
Joint for single and double wire rack tube.
Joint tube grille à fil simple et double.
Крепеж для трубы и решетки с рамкой одинарной или двойной.

6029	
	h = 25 a = 34 b = Ø 25 c = Ø 6
	2,98
	50
	CR V

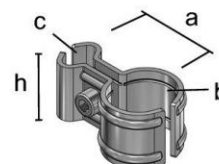

griglia





6030

Giunto tubo griglia su due lati per griglia lati con cornice filo semplice e doppio.
Two side grill tube joint for single and double wire rack frame.
Joint tube grille sur deux côtés pour grille à fil simple et double.
Крепеж для трубы и двух решеток с рамкой одинарной или двойной.

6030	
	h = 25 a = 68 b = Ø 6 c = Ø 25
	4,25
	50
	CR V

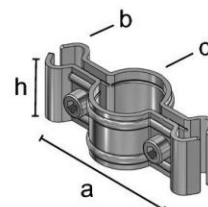

6031

Ripiano in griglia 900x400 mm da montare con giunti art. 6029 e 6030.
900x400 mm grill plate to assemble with joints art. 6029 and 6030.
Tablette en grille 900x400 mm à monter avec joints art. 6029 et 6030.
Полка в виде решетки 900x400 мм, монтируемая с изд. 6029 и 6030.



6031	
	a = 900 b = 400 c = 34 d = 36
	3,60
	2
	CR V

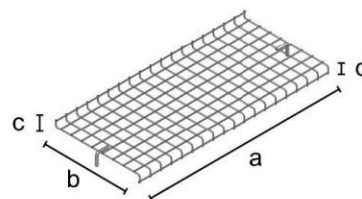

6032

Supporto per appenderia in tubo Ø 25.
Support for clothes rail with tube Ø 25.
Support pour porte-vêtement avec tube Ø 25.
Крепеж для трубы-вешала Ø 25.



6032	
	a = 100
	0,24
	2
	CR V

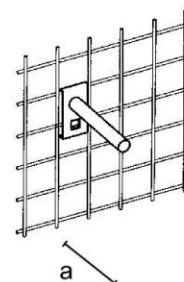



6034

Base per griglia.
Grill base.
Base pour grille.
База для решетки.



6034	
mm	h = 800 - Ø 25 a = 600 - Ø 32
Kg	2,60
Pcs/m²	2
	CR
	V

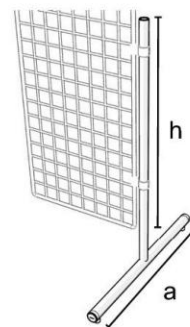

6035

Base per griglia.
Grill base.
Base pour grille.
База для решетки.



6035	
mm	h = 200 - Ø 25 a = 600 - Ø 32
Kg	1,72
Pcs/m²	2
	CR
	V

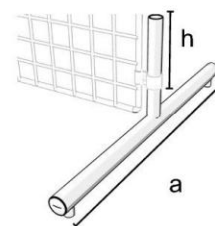

6036A / 6036B

Supporto porta blister.
Blister holder hook.
Crochet porte blister.
База для держателей блистеров.



	6036A	6036B
mm	a = 100	a = 150
Kg	0,37	0,43
Pcs/m²	5	5
	CR	CR
	V	V

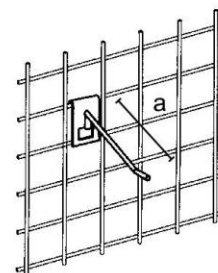



6037A / 6037B

Supporto porta blister.
Blister holder hook.
Crochet porte blister.
База для держателей блистеров.

	6037A		6037B	
mm	a = 200		a = 300	
Kg	0,50		0,60	
Pcs/m²	5		5	
	CR	V	CR	V

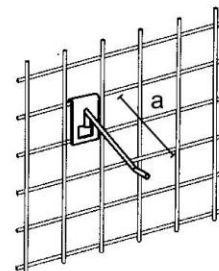

6038

Supporto espositore in filo per pantaloni.
Wire trousers stand.
Support pour pantalons en fil.
Кронштейн для брюк.

6038		
mm	a = 300	
Kg	0,30	
Pcs/m²	2	
	CR	V

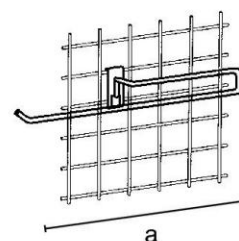

6039

Supporto per ripiani.
Shelf bracket.
Console porte-étagères.
Полкодержатель.

6039		
mm	h = 190 a = 250 b = 45	
Kg	0,41	
Pcs/m²	2	
	CR	V

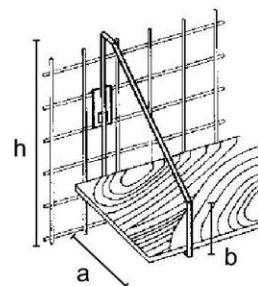



6040A / 6040B / 6040C

Supporto rettangolare per appenderia.
Rectangular support for clothes.
Support rectangulaire rails porte-vêtement.
Кронштейн-вешало.

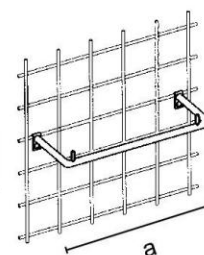

	6040A		6040B		6040C	
mm	a = 550		a = 650		a = 950	
Kg	1,54		1,83		2,20	
Pcs/m ²	2		2		2	
	CR	V	CR	V	CR	V

6041

Supporto espositore girevole.
Revolving support for clothes.
Support présentoir tournant.
Кронштейн-карусель.



6041	
mm	a = 280 b = 130
Kg	1,10
Pcs/m ²	2
	CR V

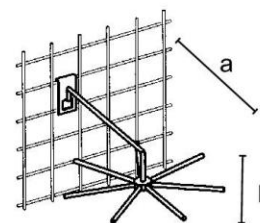

6042

Supporto espositore dritto in tubo Ø 25 mm.
Straight Ø 25 tube support for clothes.
Support présentoir droit en tube Ø 25 mm.
Кронштейн-вешало прямой из трубы Ø 25 мм.





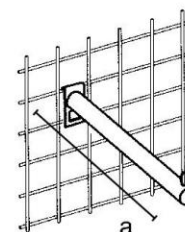

6042	
mm	a = 310
Kg	1,35
Pcs/m ²	5
	CR V





6043



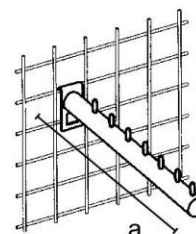

Supporto espositore inclinato in tubo Ø 25.
Inclined Ø 25 tube support for clothes.
Support présentoir incliné en tube Ø 25 mm.
Кронштейн-вешало наклонный из трубы Ø 25 мм.

6043	
 a = 340	
 1,60	
 5	
 CR	V



6044



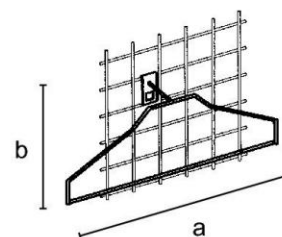

Supporto appendiabiti.
Support for hooks.
Support porte-vêtements.
Кронштейн-вешалка.

6044	
 a = 450 b = 205	
 1,00	
 2	
 CR	V



6045

Supporto espositore a cremagliera inclinato.
Inclined pitch support for clothes.
Support présentoir à crémaillère incliné.
Кронштейн-вешало наклонный волнообразный.



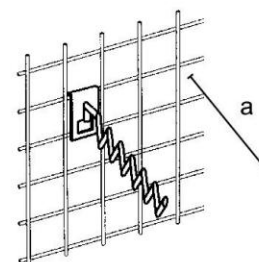

6045	
 a = 290	
 1,05	
 5	
 CR	V





6046



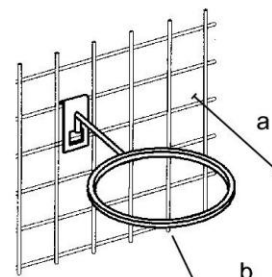

Portapallone.
Ball support.
Support pour ballon.
Держатель мяча.

6046	
	a = 300 b = Ø 150
	0,81
	5
	CR
	V



6047



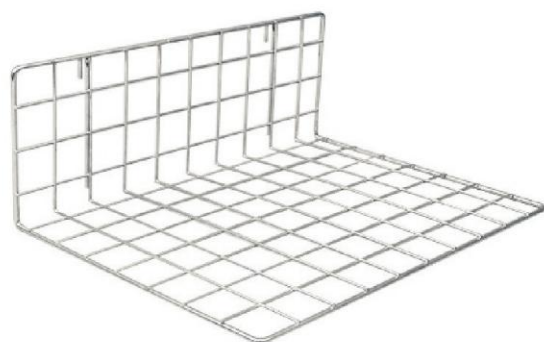
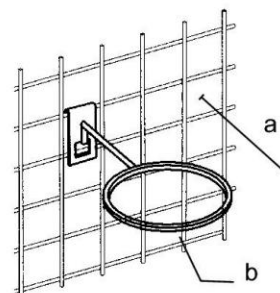

Portapallone.
Ball support.
Support pour ballon.
Держатель мяча.

6047	
	a = 300 b = Ø 90
	0,78
	5
	CR
	V



6048A / 6049A

Ripiano in griglia ad "L".
"L" grill plate.
Tablette en grille à "L".
Полка в виде решетки "L"-образная.



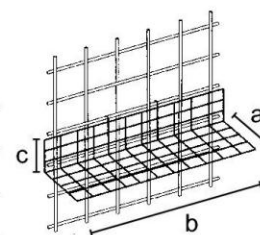

	6048A	6049A
	a = 200 b = 400 c = 155	a = 300 b = 400 c = 155
	1,10	1,41
	2	2
	CR	CR
	V	V





6050



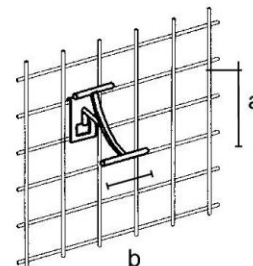

Portascarpe frontale.
Frontal shoe support.
Support frontale pour chaussures.
Экспозитор для обуви фронтальный.

6050		
	a = 115 b = 60	
mm		
	0,26	
	2	
	CR	V



6050A



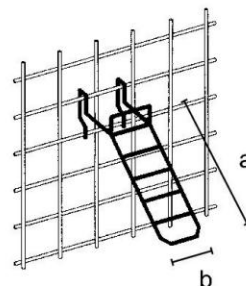

Portascarpe frontale.
Frontal shoe support.
Support frontale pour chaussures.
Экспозитор для обуви фронтальный.

6050A		
	a = 250 b = 90	
mm		
	0,34	
	2	
	CR	V



6050B

Portascarpe laterale.
Side shoe support.
Support latéral pour chaussures.
Экспозитор для обуви боковой.



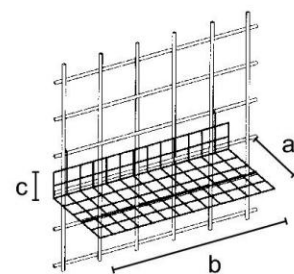

6050B		
	a = 125 b = 325 c = 80	
mm		
	0,56	
	2	
	CR	V

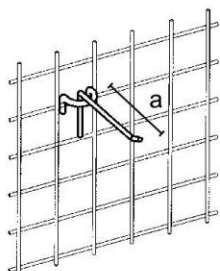

6051A / 6051B / 6051C / 6051D

Gancio porta blister semplice in tondino.
Simple blister holder wire hook.
Support à un seul fil pour blister.
Крючок одинарный для блистеров.





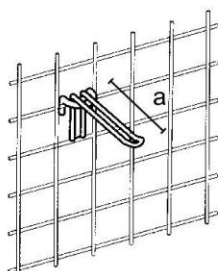

	6051A		6051B		6051C		6051D	
 mm	a = 100		a = 150		a = 200		a = 300	
 Kg	0,32		0,38		0,42		0,53	
 Pcs/m ²	5		5		5		5	
	CR	V	CR	V	CR	V	CR	V

6052A / 6052B / 6052C

Gancio porta blister doppio in tondino.
Double blister holder wire hook.
Support double fil pour blister.
Крючок двойной для блистеров.





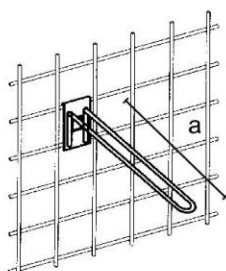

	6052A		6052B		6052C	
 mm	a = 150		a = 200		a = 300	
 Kg	0,53		0,61		0,70	
 Pcs/m ²	5		5		5	
	CR	V	CR	V	CR	V

6069A / 6069B / 6069C

Gancio porta blister doppio.
Double blister holder wire hook.
Support double fil pour blister.
Крючок двойной для блистеров.







	6069A		6069B		6069C	
 mm	a = 150		a = 200		a = 300	
 Kg	0,50		0,60		0,75	
 Pcs/m ²	5		5		5	
	CR	V	CR	V	CR	V

griglia



6071A / 6071B



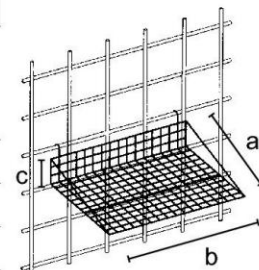

Ripiano in griglia angolare con tiranti.
Angular grill plate with tension wires.
Tablette angulaire en grille avec entretoises.
Полка в виде решетки угловая.

	6071A		6071B	
 mm	a = 300 b = 400 c = 160		a = 400 b = 600 c = 160	
 Kg	0,84		1,25	
 Pcs/m ²	1		1	
	CR	V	CR	V



6072A / 6072B



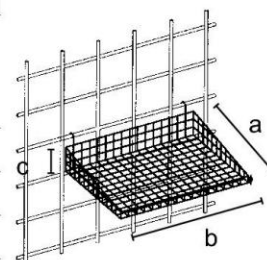

Cesto in griglia.
Grill basket.
Panier en grille.
Корзина в виде решетки.

	6072A		6072B	
 mm	a = 300 b = 400 c = 160		a = 400 b = 600 c = 160	
 Kg	1,05		1,57	
 Pcs/m ²	1		1	
	CR	V	CR	V



6073

Supporto in filo per camicie.
Wire rack support for shirts.
Support présentoir en fil pour chemises.
Полка для рубашек.

	6073	
 mm	a = 380 b = 250 c = 54	
 Kg	1,61	
 Pcs/m ²	2	
	CR	V

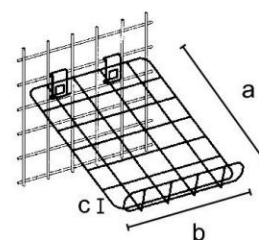







6074

Porta volantini.
Hand bill holder.
Porte-prospectus.
Экспозитор для рекламных листовок.





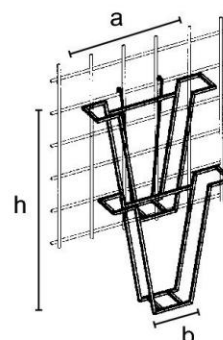

6074	
 mm	h = 300 a = 210 b = 120
 Kg	0,48
 Pcs/m²	2
	CR
	V



6075

Porta CD semplice.
Simple CD holder.
Porte CD simple.
Экспозитор для CD.





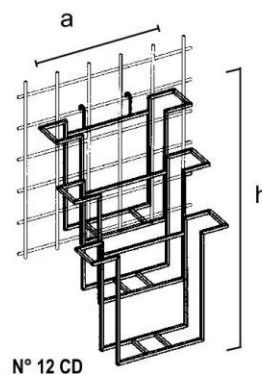

6075	
 mm	h = 180 a = 150
 Kg	0,21
 Pcs/m²	1
	CR
	V

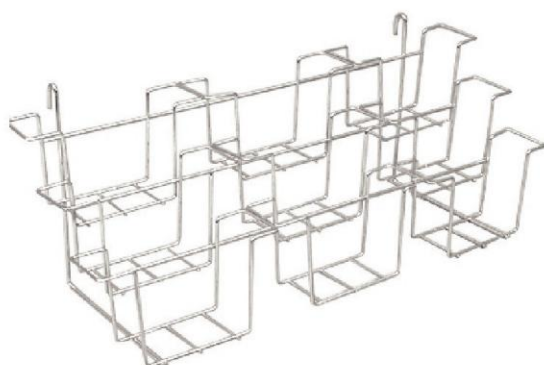

6076

Porta CD doppio.
Multiple CD holder.
Porte CD multiple.
Экспозитор двойной для CD.





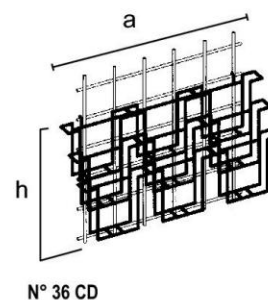

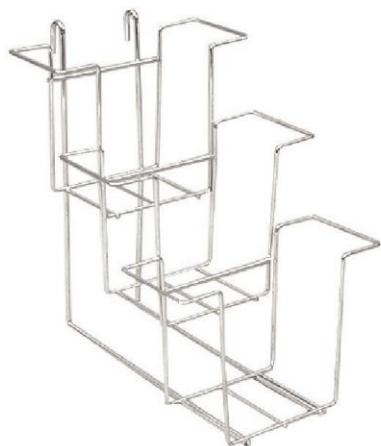
6076	
 mm	h = 180 a = 460
 Kg	0,57
 Pcs/m²	1
	CR
	V



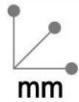

6077



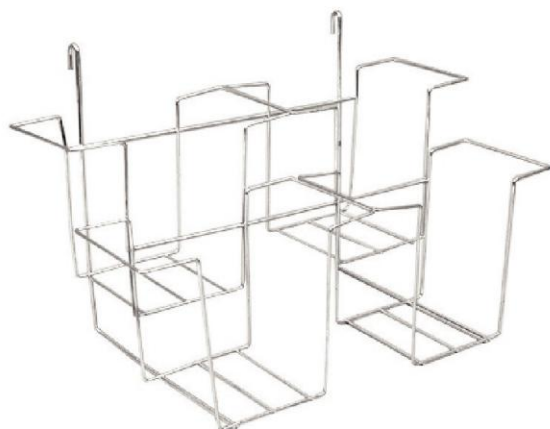
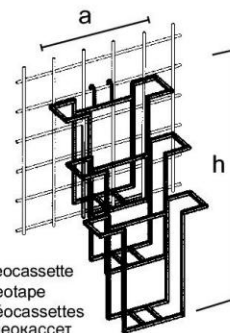

Porta videocassette semplice.
Simple videotape holder.
Porte-vidéocassettes simple.
Экспозитор для видеокассет.

6077		
	h = 230 a = 145	
	0,28	
	1	
	CR	V

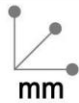

6081

Porta calze.
Stocking holder.
Porte-bas.
Экспозитор для чулок.

6081		
	h = 190 a = 390	
	0,48	
	1	
	CR	V

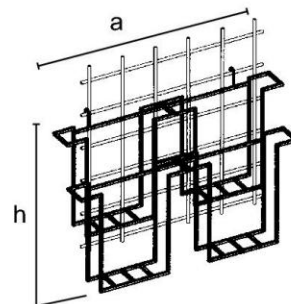



6083A

Bancarella.
Stall.
Panier d'exposition.
Накопитель для супермаркетов.

6083A	
	h = max 800 mm a = 200 b = 750 c = 750
	15,00
	1
	CR V

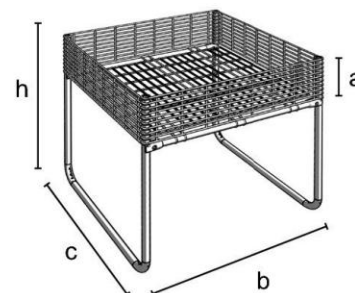

6083B

Bancarella.
Stall.
Panier d'exposition.
Накопитель для супермаркетов.

6083B	
	h = max 800 mm a = 400 b = 750 c = 750
	21,00
	1
	CR V

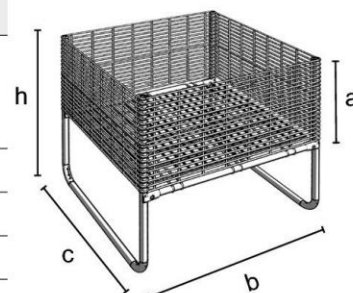

6083C

Bancarella.
Stall.
Panier d'exposition.
Накопитель для супермаркетов.

6083C	
	h = 760 a = 390 b = 740 c = 740
	12,60
	1
	CR V

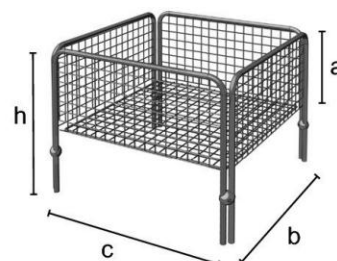

griglia



6084

Giunto angolare per griglia con filo semplice e doppio.
 Angular joint for double and single wire rack.
 Joint d'angle pour grille avec fil simple et double.
 Крепеж угловой для решетки с рамкой одинарной и двойной.

6084	
a = 24 mm	
Kg	0,58
Pcs/m ²	10
	CR V

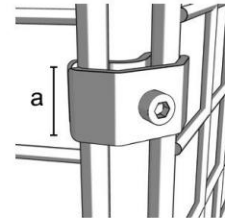

6085A / 6085B / 6085C

Gancio portablister con porta prezzi.
 Blisterholder hook with price holder.
 Crochet porte blister avec porte prix.
 Крючок-держатель блистеров с ценниками или артикулами.

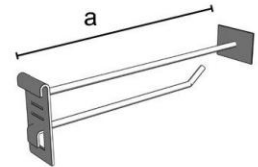

	6085A	6085B	6085C
a = 150 mm		a = 200	a = 300
Kg	0,29	0,32	0,42
Pcs/m ²	2	2	2
	CR V	CR V	CR V



6086DX/SX

Coppia supporti per appenderia per tubo ovale 30x15 mm.
 Support for clothes rail for 30x15 mm oval tube (Pair).
 Support de tringle à vêtement pour tube ovale 30x15 mm (Couple).
 Держатель овальной трубы-вешала 30x15 мм (Пара).



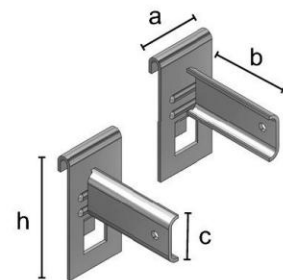

6086DX/SX	
h = 77 a = 38 b = 61 c = 29 mm	
Kg	0,24
Pcs/m ²	2
	CR V





6087A / 6087B



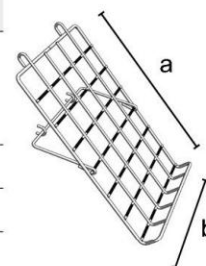

Espositore orientabile per riviste, camicie ecc.
Adjustable stand for magazines, shirts, etc.
Porte-revues, chemises etc, orientable.
Держатель регулируемый для журналов, рубашек и т.д.

	6087A		6087B	
 mm	a = 365 b = 250		a = 365 b = 500	
 Kg	1,12		2,12	
 Pcs/m ²	2		2	
	CR	V	CR	V



6088



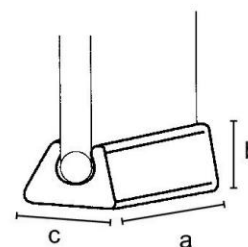

Piedino per griglia filo semplice.
Single wire grill foot.
Pied pour grille fil simple.
Ножка для решетки с одинарной рамой.

6088	
 mm	a = 30 b = 19 c = 19
 Kg	0,46
 Pcs/m ²	100
	PL



6089

Porta cappello.
Hat holder.
Support porte-chapeau.
Экспозитор шляпы.

6089		
 mm	a = Ø 120 b = 125 c = 200	
 Kg	0,43	
 Pcs/m ²	2	
	CR	V

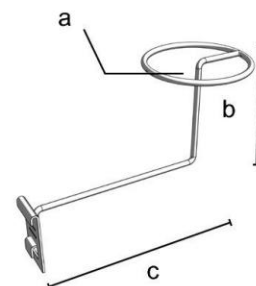

griglia



GRIGLIA 6000				
articolo	descrizione	cromato	verniciato	pl/legno/ns
6000	PANN. GRIGLIA MAGLIA 50X50 MM. 2000X800 CORN. FILO SEMPL.	85.00	73.00	
6001	PANN. GRIGLIA MAGLIA 50X50 MM. 2000X600 CORN. FILO SEMPL.	66.00	59.00	
6002	PANN. GRIGLIA MAGLIA 50X50 MM. 2000X400 CORN. FILO SEMPL.	53.00	46.00	
6003	PANN. GRIGLIA MAGLIA 50X50 MM. 1500X800 CORN. FILO SEMPL.	66.00	58.00	
6004	PANN. GRIGLIA MAGLIA 50X50 MM. 1500X600 CORN. FILO SEMPL.	51.00	46.00	
6005	PANN. GRIGLIA MAGLIA 50X50 MM. 1500X400 CORN. FILO SEMPL.	39.50	36.00	
6006	PANN. GRIGLIA MAGLIA 50X50 MM. 1000X800 CORN. FILO SEMPL.	45.50	40.50	
6007	PANN. GRIGLIA MAGLIA 50X50 MM. 1000X600 CORN. FILO SEMPL.	36.50	33.00	
6008	PANN. GRIGLIA MAGLIA 50X50 MM. 1000X400 CORN. FILO SEMPL.	29.00	26.50	
6009	PANN. GRIGLIA MAGLIA 50X50 MM. 800X400 CORN. FILO SEMPL.	25.00	22.50	
6010	PANN. GRIGLIA MAGLIA 50X50 MM. 600X600 CORN. FILO SEMPL.	29.00	26.50	
6011	PANN. GRIGLIA MAGLIA 50X50 MM. 400X400 CORN. FILO SEMPL.	16.00	13.00	
6016	PANN. GRIGLIA MAGLIA 50X50 MM. 1500X1000 CORN. FILO SEMPL.	77.00	67.00	
6017	PANN. GRIGLIA MAGLIA 50X50 MM. 1000X1000 CORN. FILO SEMPL.	55.00	50.00	
6053	PANN. GRIGLIA MAGLIA 50X50 MM. 2000X1000 CORN. FILO SEMPL.	104.00	89.00	
6054	PANN. GRIGLIA MAGLIA 50X50 MM. 800X800 CORN. FILO SEMPL.	40.00	36.50	
6055	PANN. GRIGLIA MAGLIA 50X50 MM. 800X600 CORN. FILO SEMPL.	33.50	30.50	
6056	PANN. GRIGLIA MAGLIA 50X50 MM. 600X400 CORN. FILO SEMPL.	21.00	18.50	
6012	PANN. GRIGLIA TRIAN. MAGLIA 50X50 MM.600X600 CORN. FL SEM.	33.00	28.50	
6013	PANN. GRIGLIA TRIAN. MAGLIA 50X50 MM.400X400 CORN. FL SEM.	23.50	21.00	
6014	PANN. GRIGLIA CIRC. MAGLIA 50X50 MM. 600X600 FILO SEMPL.	34.50	30.50	
6015	PANN. GRIGLIA CIRC. MAGLIA 50X50 MM. 400X400 FILO SEMPL.	28.50	24.00	
6024	SUPPORTO PER RIPIANO IN LEGNO O CRISTALLO	2.30	2.20	
6025	SUPPORTO PER RIPIANO IN GRIGLIA FILO SEMPLICE E DOPPIO	2.30	2.20	
6026	GIUNTO PARALLELO PER GRIGLIA C/CORNICE FILO SEMPL. E DOP.	2.00	1.80	
6027	SUPPORTO A BANDIERA GRIGLIA C/CORNICE FILO SEMPL. E DOP.	1.50	1.30	
6028	SUPPORTO A PARETE PER GRIGLIA C/CORN. FILO SEMPL.E E DOP.	1.80	1.60	
6029	GIUNTO TUBO GRIGLIA CON CORNICE FILO SEMPLICE E DOPPIO	2.20	2.00	
6030	GIUNTO TUBO SU 2 LATI PER GRIGLIA C/CORN. FILO SEMPL./DOP.	3.70	3.20	
6031	RIP. IN GRIGLIA MM. 900X400 DA MONT. C/GIUNTI ART. 6029/6030	45.50	40.00	
6032	SUPPORTO APPENDERIA IN TUBO Ø 25	8.00	6.60	
6034	BASE PER GRIGLIA	22.00	20.50	
6035	BASE PER GRIGLIA	20.50	19.00	
6036A	SUPPORTO PORTA BLISTER MM. 100	4.20	3.80	
6036B	SUPPORTO PORTA BLISTER MM. 150	4.40	3.90	
6037A	SUPPORTO PORTA BLISTER MM. 200	4.70	4.40	
6037B	SUPPORTO PORTA BLISTER MM. 300	5.40	4.50	
6038	SUPPORTO ESPOSITORE IN FILO PER PANTALONI	9.50	7.60	
6039	SUPPORTO PER RIPIANI	9.50	7.60	
6040A	SUPPORTO RETTANGOLARE PER APPENDERIA MM. 550	20.50	18.50	
6040B	SUPPORTO RETTANGOLARE PER APPENDERIA MM. 650	21.00	19.00	
6040C	SUPPORTO RETTANGOLARE PER APPENDERIA MM. 950	22.00	19.50	
6041	SUPPORTO ESPOSITORE GIREVOLE	40.50	32.00	
6042	SUPPORTO ESPOSITORE DIRITTO IN TUBO Ø 25	11.00	10.00	
6043	SUPPORTO ESPOSITORE INCLINATO IN TUBO Ø 25	13.00	11.50	
6044	SUPPORTO APPENDIABITI	17.00	16.00	
6045	SUPPORTO ESPOSITORE A CREMAGLIERA INCLINATO	8.50	7.60	
6046	PORTAPALLONE	10.00	8.80	
6047	PORTAPALLONE	10.00	8.80	
6048A	RIPIANO IN GRIGLIA AD "L" MM. 200	18.00	16.00	
6049A	RIPIANO IN GRIGLIA AD "L" MM. 300	19.00	17.00	
6050	PORTASCARPE FRONTALE	11.00	9.10	
6050A	PORTASCARPE FRONTALE	11.00	9.10	
6050B	PORTASCARPE LATERALE	17.50	14.50	
6051A	GANCIO PORTA BLISTER SEMPLICE IN TONDINO MM. 100	3.90	3.70	
6051B	GANCIO PORTA BLISTER SEMPLICE IN TONDINO MM. 150	4.00	3.80	
6051C	GANCIO PORTA BLISTER SEMPLICE IN TONDINO MM. 200	4.10	3.90	
6051D	GANCIO PORTA BLISTER SEMPLICE IN TONDINO MM. 300	4.20	3.90	
6052A	GANCIO PORTA BLISTER DOPPIO IN TONDINO MM. 150	4.60	4.20	
6052B	GANCIO PORTA BLISTER DOPPIO IN TONDINO MM. 200	5.00	4.70	
6052C	GANCIO PORTA BLISTER DOPPIO IN TONDINO MM. 300	5.20	4.80	
6069A	GANCIO DOPPIO PORTA BLISTER MM. 150	7.60	6.40	
6069B	GANCIO DOPPIO PORTA BLISTER MM. 200	7.70	6.70	
6069C	GANCIO DOPPIO PORTA BLISTER MM. 300	7.90	6.90	
6071A	RIPIANO IN GRIGLIA ANGOLARE CON TIRANTI MM. 300X400	25.50	22.50	

6071B	RIPIANO IN GRIGLIA ANGOLARE CON TIRANTI MM. 400X600	33.50	30.00	
6072A	CESTO IN GRIGLIA MM. 300X400	34.00	27.50	
6072B	CESTO IN GRIGLIA MM. 400X600	49.00	42.50	
6073	SUPPORTO IN FILO PER CAMICIE	18.50	15.00	
6074	PORTA VOLANTINI	12.50	12.00	
6075	PORTA CD SEMPLICE	15.50	13.50	
6076	PORTA CD DOPPIO	34.00	31.50	
6077	PORTA VIDEOCASSETTE SEMPLICE	15.50	13.50	
6081	PORTA CALZE	25.00	20.50	
6083A	BANCARELLA MM. 750X750 H. MM. 200	181.00	169.00	
6083B	BANCARELLA MM. 750X750 H. MM. 400	219.00	14.50	
6083C	BANCARELLA	153.00	142.00	
6084	GIUNTO ANGOLARE PER GRIGLIA CON FILO SEMPLICE E DOPPIO	5.40	4.10	
6085A	GANCIO PORTABLISTER CON PORTA PREZZI MM. 150	7.80	7.30	
6085B	GANCIO PORTABLISTER CON PORTA PREZZI MM. 200	8.00	7.60	
6085C	GANCIO PORTABLISTER CON PORTA PREZZI MM. 300	9.30	7.90	
6086	SUPPORTO PER APPENDERIA IN TUBO OVALE 30X15 MM.	11.50	10.00	
6087A	ESPOSITORE ORIENTABILE PER RIVISTE, CAMICIE MM. 250	25.50	20.50	
6087B	ESPOSITORE ORIENTABILE PER RIVISTE, CAMICIE MM. 500	34.00	29.00	
6088	PIEDINO PER GRIGLIA FILO SEMPLICE			0.40
6089	PORTA CAPPELLO	13.50	11.50	

Preise ab unseren Lokalitäten. Preisänderung vorbehalten.
Diese Preisliste annulliert die vorhergehende.
Lieferfrist ca. 4 Wochen ab Auftragsbestätigung. Exkl. MwSt

Prix départ de nos locaux. Sous réserve de modifications. TVA non incluse
La présente liste annule et remplace toute précédente liste.
Délai de livraison hors stock, env. 4 sem. dès confirmation commande.