

Ladeneinrichtungen und Zubehör
Agencement de magasins et fournitures



 **New
Prices**

DITTA DISPLAY
info@dittadisplay.ch
1, www.dittadisplay.ch

TEL 021 691 12 12 FAX 021 691 13 13
TEL 043 495 06 61 FAX 043 495 06 62

Ch. des Champs-Courbes 1,
ZI En Vallaire Est, 1024 Ecublens VD 1

legenda

simboli

Symbols / Symbole / Symboles / Símbolos

●	Colore / Color / Farbe / Couleur / Color
A	Larghezza / Width / Breite / Largeur / Anchura
B	Altezza / Height / Höhe / Hauteur / Altura
C	Profondità / Depth / Tiefe / Profondité / Profundidad
p	Passo cremagliera / Upright pitch / Shlitzteilung / Pas de la crémaillère / Paso bisagra
Ø	Diametro / Diameter / Durchmesser / Diamètre / Diámetro
s	Spessore / Thickness / Stärke / Epaisseur / Grueso



strutture

Structure / Struktur / Structure / Estructura

	CL Cromo lucido Chrome finishing Verchromt Chromé Cromo brillante		GA Grigio alluminio Aluminium grey Aluminium Grau Gris aluminium Gris aluminio		VT Verniciato trasparente Transparent paint Transparent lackiert Verni transparent Pintado transparente
--	---	--	--	--	---

ripiani

Shelf finishing / Fachbödenfarben / Couleurs tablettes et étagères / Colores de estantes

	AC Acero Maple Ahorn Eable Arce		RS Rovere sbiancato Light oak Helleiche Rouvre claire Roble blanqueado		RM Rovere moro Dark oak Dunkeleiche Rouvre foncé Roble oscuro		BCO Bianco White Weiss Blanc Blanco
	CA Cristallo temperato acidato Matt tempered glass Matt gehärteter Kristall Matt verre/tempéré Vidrio templado satinado		CT Cristallo temperato trasp. Transparent tempered glass Gehärtetes Kristall-Klarglas Verre transparent tempéré Vidrio templado transparente		PLX Plexiglass opale satinato Opal acrylic glass Milch-Plexiglas Plexi opale Plexi ópalo		

dimensioni

Dimensions / Dimensions / Dimensionen / Dimensiones

Schienale

Back panel / Rückenwand
Panneau de fond / Panel de fondo

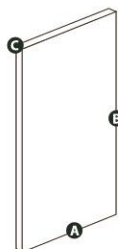

Schienale di testata

Back panel for head shelving unit
Rückenwand für Frontteil
Panneau de fond pour tête
Panel de fondo

Piano di base

Bottom shelf / Bodenplatte
Tablette de base / Superficie de apoyo

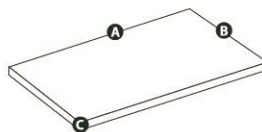

finiture

Finishing / Farbe / Finitions / Colores

	CL Cromo lucido Chrome finishing Verchromt Chromé Cromo brillante		CO Cromo opaco Matt chrome Matt Verchromt Matt chromé Cromo opaco		NS Nichel satinato Nickel glazed Satinert Satiné Niquel satinado		ZN Zincato Zinc-plated Verzinkt Zingue Cinc plateó
---	---	---	---	---	--	---	--



Zoa si caratterizza per il suo tubo rettangolare, snello ed elegante. È un sistema modulare che permette di giocare con le forme per esprimere un nuovo concetto di esposizione con un risultato altamente estetico e di notevole effetto visivo. Completo in ogni sua parte suggerisce soluzioni espositive per ogni ambiente.

Zoa features a slim and elegant rectangular tube. It is a modular system that allows to play with shapes to express a new display concept with a highly aesthetic result and a remarkable visual effect. If duly fitted with its own elements, it suggests display solutions suitable to any kind of environment.

Ladeneinrichtungen und Zubehör Agencement de magasins et fournitures



Zoa zeichnet sich durch die schlanke und elegante Struktur aus rechteckigem Rohr aus. Es handelt sich um ein Modulsystem, welches ein Spiel mit verschiedenen Formen erlaubt, um so ein neues, höchst ästhetisches und auffälliges Präsentationskonzept zu realisieren. Als vollkommenes Komplettsystem regt es zu Einrichtungsideen für jegliche Räume an.

Zoa se caractérise pour son tube rectangulaire, élancé et élégant. C'est un système modulaire qui permet de jouer avec les formes pour exprimer un nouveau concept de présentation avec un résultat hautement esthétique et de considérable effet visuel. Complet en chaque partie, il suggère des solutions d'agencement pour tout milieu.

Zoa se caracteriza por el tubo rectangular, sobrio y elegante. Es un sistema modular que permite jugar con las formas para expresar un nuevo concepto de exposición con resultado muy estético y de alto efecto visual. Completo en cada parte sugiere soluciones de exposición para todos los locales.

Ladeneinrichtungen und Zubehör Agencement de magasins et fournitures

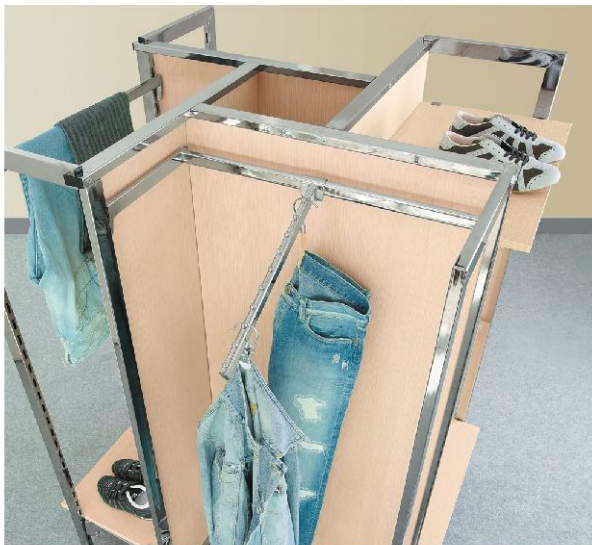













DITTA DISPLAY
info@dittadisplay.ch
1, www.dittadisplay.ch

TEL 021 691 12 12 FAX 021 691 13 13
TEL 043 495 06 61 FAX 043 495 06 62

Ch. des Champs-Courbes 1,
ZI En Vallaire Est, 1024 Ecublens VD 5

zoa

indice

	parete attrezzata wall system unit / Wandstruktur / système murale / pared equipada	86
	accessori per parete attrezzata accessories for wall system / Zubehör für Wandstruktur accessoires pour système murale / accesorios para paredes	87
	gondole gondolas / Gondeln / góndolas / góndolas	90
	accessori per gondole accessories for gondolas / Zubehör für Gondeln accessoires pour góndolas / accesorios para góndolas	91
	stender garment rail / Konfektionständer / penderie / perchero	94
	stender curvo curved garment rail / bogenförmiger Ständer / penderie courbe / perchero curvo	95
	stender semicircolare semicircular rail / Ständer halbrunden / penderie semi-circulaire / perchero semicircular	96
	stender Swing rail Swing / Rollständer Swing / penderie Swing / perchero Swing	97
	espositore a 3 piani 3-tier display unit / Mittelraumelement, 3-stufig / présentoir 3 niveaux / espositor escalonado	98
	banco espositivo display table / Vorlagentisch / comptoir / mostrador	100
	seduta in ecopelle stool, synthetic leather / Hocker aus synthetischem Leder / tabouret en cuir / taburete simil piel	102
	seduta curva in ecopelle curved stool, synthetic leather / gebogener Hocker aus synthetischem Leder tabouret courbe en cuir / taburete curvo simil piel	103

parete attrezzata

Struttura

Structure / Struktur / Structure / Estructura

CODICE	◆	A	B	C	p
Z033250	CL	-	250	-	5
Z033255	VT	-	250	-	5

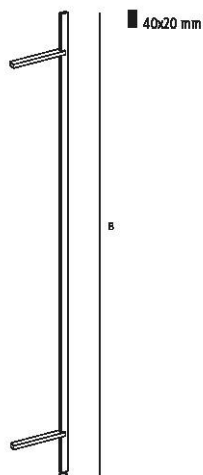







Montante per parete attrezzata

Upright for wall system unit
Säule für Wandstruktur
Montant pour système murale
Montante para pared equipada

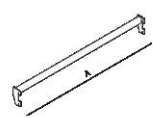

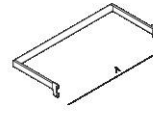
Zo2 parete attrezzata

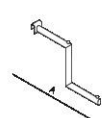
Accessori per parete attrezzata Accessories for wall system / Zubehör für Wandstruktur Accessoires pour système murale / Accesorios para pared equipada

	<p>Appendieria a spalla Hanging bar Konfektionsstange Guidons penderie Barra colgadora</p>	<table border="1"> <thead> <tr> <th>CODICE</th> <th>▲</th> <th>A</th> <th>B</th> <th>C</th> <th>p</th> <th>Ø</th> </tr> </thead> <tbody> <tr> <td>RO25660</td> <td>CL</td> <td>66,6</td> <td>-</td> <td>-</td> <td>5</td> <td>-</td> </tr> <tr> <td>RO25665</td> <td>VT</td> <td>66,6</td> <td>-</td> <td>-</td> <td>5</td> <td>-</td> </tr> <tr> <td>RO25990</td> <td>CL</td> <td>100</td> <td>-</td> <td>-</td> <td>5</td> <td>-</td> </tr> <tr> <td>RO25995</td> <td>VT</td> <td>100</td> <td>-</td> <td>-</td> <td>5</td> <td>-</td> </tr> </tbody> </table> 	CODICE	▲	A	B	C	p	Ø	RO25660	CL	66,6	-	-	5	-	RO25665	VT	66,6	-	-	5	-	RO25990	CL	100	-	-	5	-	RO25995	VT	100	-	-	5	-
CODICE	▲	A	B	C	p	Ø																															
RO25660	CL	66,6	-	-	5	-																															
RO25665	VT	66,6	-	-	5	-																															
RO25990	CL	100	-	-	5	-																															
RO25995	VT	100	-	-	5	-																															
	<p>Barra porta broches Display bar Konfektionsrahmen Tube penderie Barra porta-brazos</p>	<table border="1"> <thead> <tr> <th>CODICE</th> <th>▲</th> <th>A</th> <th>B</th> <th>C</th> <th>p</th> <th>Ø</th> </tr> </thead> <tbody> <tr> <td>RO30660</td> <td>CL</td> <td>66,6</td> <td>-</td> <td>-</td> <td>5</td> <td>-</td> </tr> <tr> <td>RO30665</td> <td>VT</td> <td>66,6</td> <td>-</td> <td>-</td> <td>5</td> <td>-</td> </tr> <tr> <td>RO30990</td> <td>CL</td> <td>100</td> <td>-</td> <td>-</td> <td>5</td> <td>-</td> </tr> <tr> <td>RO30995</td> <td>VT</td> <td>100</td> <td>-</td> <td>-</td> <td>5</td> <td>-</td> </tr> </tbody> </table> 	CODICE	▲	A	B	C	p	Ø	RO30660	CL	66,6	-	-	5	-	RO30665	VT	66,6	-	-	5	-	RO30990	CL	100	-	-	5	-	RO30995	VT	100	-	-	5	-
CODICE	▲	A	B	C	p	Ø																															
RO30660	CL	66,6	-	-	5	-																															
RO30665	VT	66,6	-	-	5	-																															
RO30990	CL	100	-	-	5	-																															
RO30995	VT	100	-	-	5	-																															
	<p>Broche a gradino sezione ovale Stepped arm, oval section Abhänger, Stufe Ovalausschnitt Bras à gradin, section ovale Brazo a escalera sección ovalada</p>	<table border="1"> <thead> <tr> <th>CODICE</th> <th>▲</th> <th>A</th> <th>B</th> <th>C</th> <th>p</th> <th>Ø</th> </tr> </thead> <tbody> <tr> <td>BA30550</td> <td>CL</td> <td>42</td> <td>-</td> <td>-</td> <td>-</td> <td>3x1,5</td> </tr> <tr> <td>BA30555</td> <td>VT</td> <td>42</td> <td>-</td> <td>-</td> <td>-</td> <td>3x1,5</td> </tr> </tbody> </table> 	CODICE	▲	A	B	C	p	Ø	BA30550	CL	42	-	-	-	3x1,5	BA30555	VT	42	-	-	-	3x1,5														
CODICE	▲	A	B	C	p	Ø																															
BA30550	CL	42	-	-	-	3x1,5																															
BA30555	VT	42	-	-	-	3x1,5																															
	<p>Broche dritta sezione ovale Straight arm, oval section Abhänger, gerade Ovalausschnitt Bras droit, section ovale Brazo recto sección ovalada</p>	<table border="1"> <thead> <tr> <th>CODICE</th> <th>▲</th> <th>A</th> <th>B</th> <th>C</th> <th>p</th> <th>Ø</th> </tr> </thead> <tbody> <tr> <td>BA20360</td> <td>CL</td> <td>36</td> <td>-</td> <td>-</td> <td>-</td> <td>3x1,5</td> </tr> <tr> <td>BA20365</td> <td>VT</td> <td>36</td> <td>-</td> <td>-</td> <td>-</td> <td>3x1,5</td> </tr> </tbody> </table> 	CODICE	▲	A	B	C	p	Ø	BA20360	CL	36	-	-	-	3x1,5	BA20365	VT	36	-	-	-	3x1,5														
CODICE	▲	A	B	C	p	Ø																															
BA20360	CL	36	-	-	-	3x1,5																															
BA20365	VT	36	-	-	-	3x1,5																															

parete attrezzata

Accessori per parete attrezzata

Accessories for wall system / Zubehör für Wandstruktur
Accessoires pour système murale / Accesorios para pared equipada

CODICE	▲	A	B	C	p	Ø
BA30420	●	CL	45	-	-	- 3x1,5
BA30425	●	GA	45	-	-	- 3x1,5



Broche inclinata sezione ovale
Sloping arm round and oval section
Abhänger, schräg Ovaleausschnitt
Bras incliné, section ovale
Brazo inclinado sección ovalada



CODICE	▲	A	B	C	p	Ø
BA30280		CL	12	-	-	-



Supporto busti per barra appenderia
Bust support for hanging bar
Büstenhalter für Konfektionsrahmen
Support buste pour barre penderie
Soportes bustos para barra colgadora



CODICE	▲	A	B	C	p	Ø
ZO50290		CL	29	-	-	-
ZO50295		VT	29	-	-	-

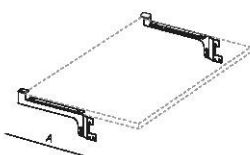

Coppia mensole
Shelf brackets (pair)
Konsole, mittig - Paar
Consoles (la paire)
Cartelas



CODICE	▲	A	B	C	p	Ø
ZO30600		CL	67	-	-	5 -
ZO30605		VT	67	-	-	5 -
ZO30970		CL	100	-	-	5 -
ZO30975		VT	100	-	-	5 -

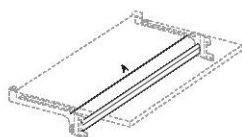

Barra appenderia per sotto-ripiano
Hanging bar for shelf
Konfektionsstange
Barre penderie avec fixation pour tablette
Barra colgadora para estante



Z03 parete attrezzata

Accessori per parete attrezzata Accessories for wall system / Zubehör für Wandstruktur Accessoires pour système murale / Accesorios para pared equipada

Supporto per ripiano in cristallo
Glass shelf support
Glasbödenträger
Support pour tablette en verre
Soporte para estante en cristal



CODICE	◆	A	B	C	p	Ø
Z037640	CL	67	23	1	-	-
Z037645	VT	67	23	1	-	-
Z037970	CL	100	23	1	-	-
Z037975	VT	100	23	1	-	-

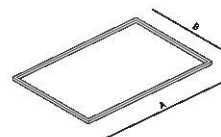

Ripiani
Shelves
Böden
Tablettes
Estantes



CODICE	◆	A	B	C	p	Ø
R0186440007	RS	64	40	1,8	-	-
Z06440018009	BCO	64	40	1,8	-	-
R008640400	CA	64	40	0,8	-	-
Z09740018007	RS	97	40	1,8	-	-
Z09740018009	BCO	97	40	1,8	-	-
Z097240008	CA	97	40	0,8	-	-



gondola

Struttura

Structure / Struktur / Structure / Estructura

CODICE	◆	A	B	C	p
Z015540	CL	100	142	71	-
Z015545	VT	100	142	71	-

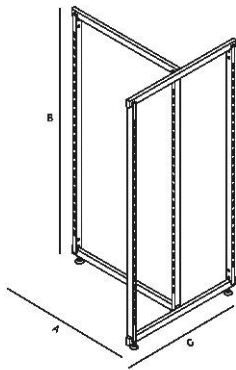

Gondola

Gondola
Gondel
Gondole
Góndola





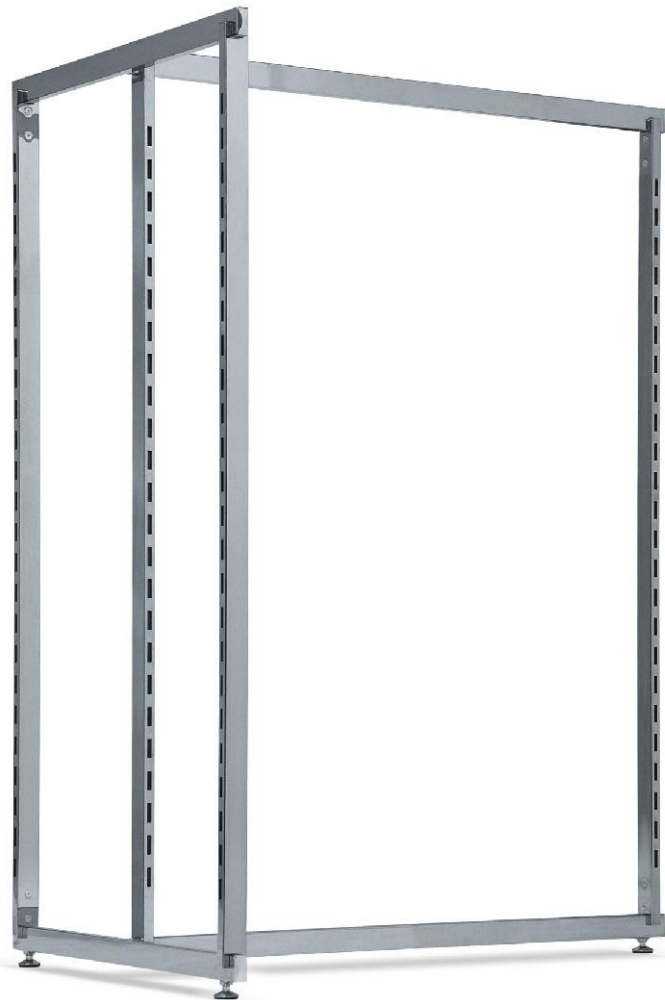



90

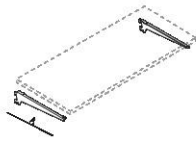

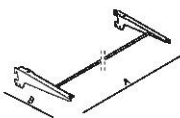
zoa gondola

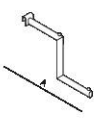
Accessori per gondola Accessories for gondola / Zubehör für Gondel Accessoires pour gondole / Accesorios para góndola

	<p>Coppia mensole Shelf brackets (pair) Konsole - Paar Consoles (la paire) Cartelas</p>	<table border="1"> <thead> <tr> <th>CODICE</th> <th>▲</th> <th>A</th> <th>B</th> <th>C</th> <th>p</th> <th>Ø</th> </tr> </thead> <tbody> <tr> <td>GO20390</td> <td>CL</td> <td>39</td> <td>-</td> <td>-</td> <td>5</td> <td>-</td> </tr> <tr> <td>GO20395</td> <td>VT</td> <td>39</td> <td>-</td> <td>-</td> <td>5</td> <td>-</td> </tr> </tbody> </table>	CODICE	▲	A	B	C	p	Ø	GO20390	CL	39	-	-	5	-	GO20395	VT	39	-	-	5	-	
CODICE	▲	A	B	C	p	Ø																		
GO20390	CL	39	-	-	5	-																		
GO20395	VT	39	-	-	5	-																		
	<p>Supporto per ripiano in cristallo Glass shelf support Kristallbodenträger Support pour tablette en glace Soporte para estante en cristal</p>	<table border="1"> <thead> <tr> <th>CODICE</th> <th>▲</th> <th>A</th> <th>B</th> <th>C</th> <th>p</th> <th>Ø</th> </tr> </thead> <tbody> <tr> <td>GO2039020</td> <td>CL</td> <td>100</td> <td>40</td> <td>-</td> <td>-</td> <td>-</td> </tr> <tr> <td>GO2039025</td> <td>VT</td> <td>100</td> <td>40</td> <td>-</td> <td>-</td> <td>-</td> </tr> </tbody> </table>	CODICE	▲	A	B	C	p	Ø	GO2039020	CL	100	40	-	-	-	GO2039025	VT	100	40	-	-	-	
CODICE	▲	A	B	C	p	Ø																		
GO2039020	CL	100	40	-	-	-																		
GO2039025	VT	100	40	-	-	-																		
	<p>Broche a gradino sezione ovale Stepped arm, oval section Abhänger, Stufe Ovalausschnitt Bras à gradin, section ovale Brazo a escalera sección ovalada</p>	<table border="1"> <thead> <tr> <th>CODICE</th> <th>▲</th> <th>A</th> <th>B</th> <th>C</th> <th>p</th> <th>Ø</th> </tr> </thead> <tbody> <tr> <td>BA30550</td> <td>CL</td> <td>42</td> <td>-</td> <td>-</td> <td>-</td> <td>3x1,5</td> </tr> <tr> <td>BA30555</td> <td>VT</td> <td>42</td> <td>-</td> <td>-</td> <td>-</td> <td>3x1,5</td> </tr> </tbody> </table>	CODICE	▲	A	B	C	p	Ø	BA30550	CL	42	-	-	-	3x1,5	BA30555	VT	42	-	-	-	3x1,5	
CODICE	▲	A	B	C	p	Ø																		
BA30550	CL	42	-	-	-	3x1,5																		
BA30555	VT	42	-	-	-	3x1,5																		
	<p>Broche dritta sezione ovale Straight arm, oval section Abhänger, gerade Ovalausschnitt Bras droit, section ovale Brazo recto sección ovalada</p>	<table border="1"> <thead> <tr> <th>CODICE</th> <th>▲</th> <th>A</th> <th>B</th> <th>C</th> <th>p</th> <th>Ø</th> </tr> </thead> <tbody> <tr> <td>BA20360</td> <td>CL</td> <td>36</td> <td>-</td> <td>-</td> <td>-</td> <td>3x1,5</td> </tr> <tr> <td>BA20365</td> <td>VT</td> <td>36</td> <td>-</td> <td>-</td> <td>-</td> <td>3x1,5</td> </tr> </tbody> </table>	CODICE	▲	A	B	C	p	Ø	BA20360	CL	36	-	-	-	3x1,5	BA20365	VT	36	-	-	-	3x1,5	
CODICE	▲	A	B	C	p	Ø																		
BA20360	CL	36	-	-	-	3x1,5																		
BA20365	VT	36	-	-	-	3x1,5																		

gondola

Accessori per gondola

Accessories for gondola / Zubehör für Gondel
Accessoires pour gondole / Accesorios para góndola

CODICE	▲	A	B	C	p	Ø
BA30420	●	CL	45	-	-	3x1,5
BA30425	●	VT	45	-	-	3x1,5



Broche inclinata sezione ovale
Sloping arm, oval section
Abhänger, schräg Ovalausschnitt
Bras incliné, section ovale
Brazo inclinado sección ovalada



CODICE	▲	A	B	C	p	Ø
BA30660	CL	67	30	-	-	-
BA30665	VT	67	30	-	-	-
BA301000	CL	100	30	-	-	-
BA301005	VT	100	30	-	-	-

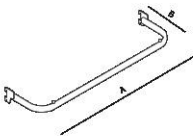

Appenderia a spalla
Straight hanging rail
Konfektionsrahmen
Guidons penderie
Barra colgadora



CODICE	▲	A	B	C	p	Ø
BA30670	CL	67	30	-	-	-
BA30990	CL	100	30	-	-	-

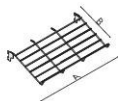

Ripiano in griglia
Grid shelf
Gitterboden
Tablette en grille
Estante rejilla



CODICE	▲	A	B	C	p	Ø
BA20660	CL	67	-	-	5	3x1,5
BA20665	VT	67	-	-	5	3x1,5
BA20990	CL	100	-	-	5	3x1,5
BA20995	VT	100	-	-	5	3x1,5



Barra porta broches
Display bar
Tragestange
Barre de charge
Barra porta-brazos



zoa gondola

Accessori per gondola

Accessories for gondola / Zubehör für Gondel
Accessoires pour gondole / Accesorios para góndola



Ripiano in lamiera forata
Perforated shelf
Lochblechboden
Tablette perforée
Estante perforado

CODICE	▲	A	B	C	p	Ø
GO40660	CL	67	40	2,5	-	-
GO40990	CL	100	40	2,5	-	-



Ripiani in laminato
Wood-laminated shelves
Holz-Laminatböden
Tablettes laminé
Estantes melamina

CODICE	▲	A	B	C	p	Ø
GO20664007	RS	67	40	1,8	-	-
GO20664009	BCO	67	40	1,8	-	-
GO20994007	RS	100	40	1,8	-	-
GO20994009	BCO	100	40	1,8	-	-

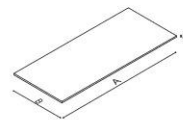

Ripiani in laminato con bordo stondato
Wood-laminated shelves with rounded edge
Holz-Laminatböden mit runder Kante
Tablettes laminé avec rond bord
Estantes melamina redondeado

CODICE	▲	A	B	C	p	Ø
GO250664007	RS	67	40	2,5	-	-
GO250664009	BCO	67	40	2,5	-	-
GO251004007	RS	100	40	2,5	-	-
GO251004009	BCO	100	40	2,5	-	-



Ripiani in cristallo temperato acidato
Matt tempered glass shelves
Gehärteter Kristallböden, satiniert
Tablettes en glace tempré acide
Estantes en cristal templado opaco

CODICE	▲	A	B	C
GO08376600	CTA	67	40	0,8
GO08379900	CTA	100	40	0,8

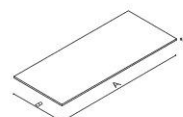

stender

Struttura

Structure / Struktur / Structure / Estructura

CODICE	◆	A	B	C	p
Z058160	CL	115	150	58	5
Z058165	VT	115	150	58	5

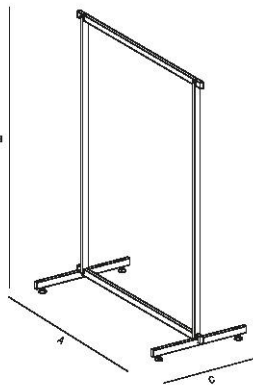

Stender

Garment rail
Ständer
Penderie
Perchero



zoa stender curvo

Stender curvo

Curved garment rail
 Bogenförmiger Ständer
 Penderie courbe
 Perchero curvo



Struttura

Structure / Struktur / Structure / Estructura

CODICE	◆	A	B	C	p
Z058150	CL	115	150	58	5
Z058155	VT	115	150	58	5

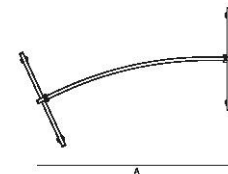
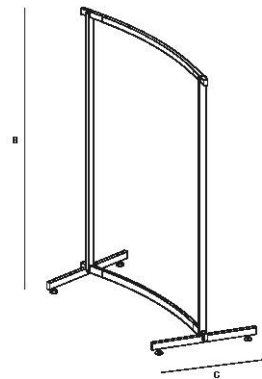

stender semicirolare

NEW

Stender Zoa Semicirolare

Semicircular Rail Zoa
Ständer halbrunden Zoa
Penderie semi-circulaire Zoa
Perchero Semicircular Zoa

CODICE	◆	A	B	C
ZOS8120	CL.	120	121	60 NEW

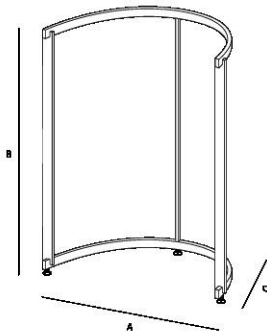

Stender Semicirolare

Semicircular Rail
Ständer halbrunden
Penderie semi-circulaire
Perchero Semicircular



96

NEW

Zoa stender SWING

Stender

Rail
Stander
Penderie
Perchero

Stender SWING

Rail Swing / Railständer Swing
Penderie Swing / Perchero Swing

CODICE	♦	A	B	C	
Z058175P09	VT / BN	68	155	60	NEW
Z058175P01	VT / NO	68	155	60	NEW

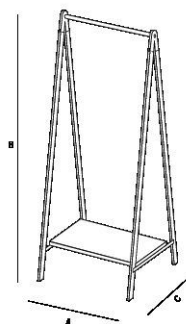

Ripiano

Shelf / Fachböden
Tablette / Estante

CODICE	♦	A	B	C	
Z018645609	BN	64	56	1,8	NEW
Z018645601	NO	64	56	1,8	NEW

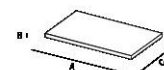

97

Ladeneinrichtungen und Zubehör Agencement de magasins et fournitures



DITTA DISPLAY
info@dittadisplay.ch
1, www.dittadisplay.ch

TEL 021 691 12 12 FAX 021 691 13 13
TEL 043 495 06 61 FAX 043 495 06 62

Ch. des Champs-Courbes 1,
ZI En Vallaire Est, 1024 Ecublens VD 19

Z02 Espositore a 3 piani

Espositore a 3 piani

3-tier display unit
Mittelraumelement, 3-stufig
Présentoir 3 niveaux
Espositor escalonado



Struttura

Structure / Struktur / Structure / Estructura

CODICE	◆	A	B	C	p
Z054100	CL	108	114	115	-
Z054105	VT	108	114	115	-

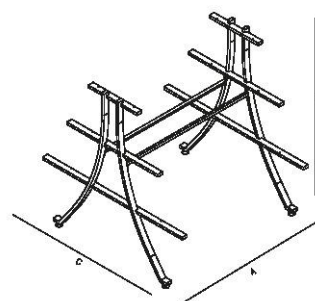

Ripiani (set 5 pz)

Shelves (pack of 5) / Böden (VPE: 5 Stück)
Tablettes (pqt. de 5) / Estantes (caja de 5)

CODICE	◆	A	B	C	p
Z05410007 (x1)	RS	104	40	1,8	-
(x2)	RS	104	37,5	1,8	-
(x2)	RS	104	57,5	1,8	-
Z05410009 (x1)	BCO	104	40	1,8	-
(x2)	BCO	104	37,5	1,8	-
(x2)	BCO	104	57,5	1,8	-

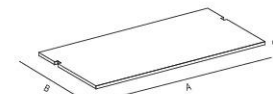
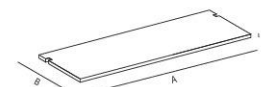

Ladeneinrichtungen und Zubehör
Agencement de magasins et fournitures

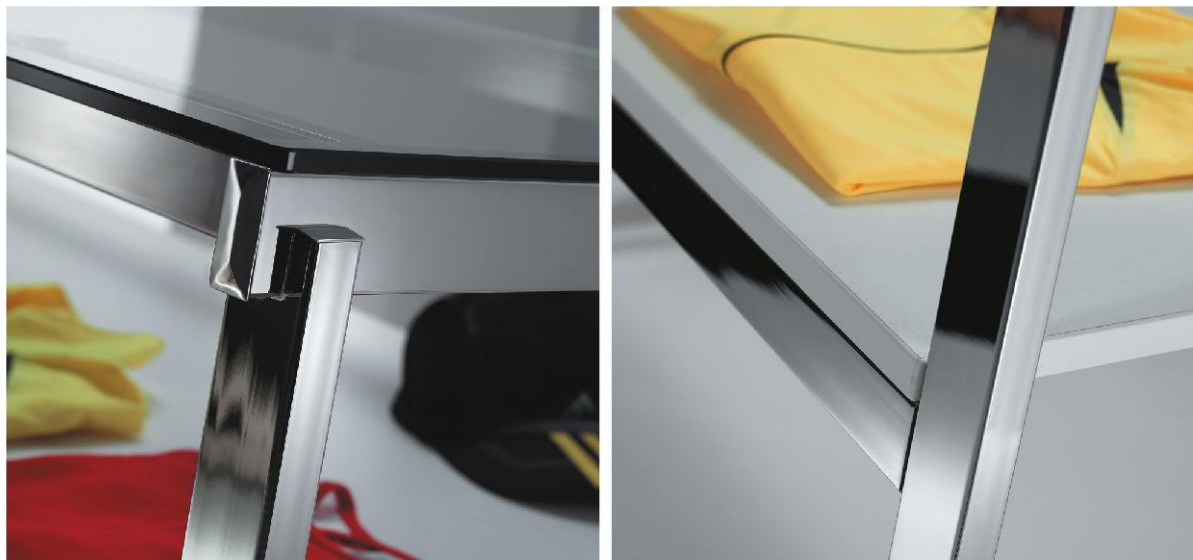

Z02 banco espositivo

Banco espositivo

Display table
Vorlagentisch
Comptoir
Mostrador



Compositions - Kombinationen
Compositions - Composiciones

CODICE		A	B	C
Z05411007	CL/CT/RS	135	91	68
Z05411009	CL/CT/BCO	135	91	68
Z05411507	VT/CT/RS	135	91	68
Z05411509	VT/CT/BCO	135	91	68

composizioni

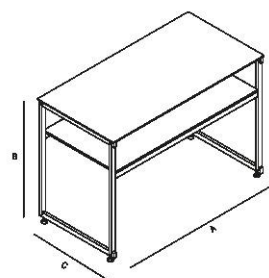

Struttura

Structure / Struktur / Structure / Estructura

CODICE		A	B	C	p
Z054110	CL	135	91	68	-
Z054115	VT	135	91	68	-

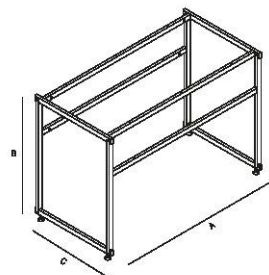

Ripiani in laminato

Wood-laminated shelves / Holz-Laminatböden
Tablettes laminé / Estantes melamina

CODICE		A	B	C	p
Z0181286507	RS	128	65	1,8	-
Z0181286509	BCO	128	65	1,8	-
VS350M137005	CT	138	70	0,8	-
VS350M137000	CA	138	70	0,8	-

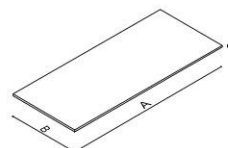

seduta

composizioni

Compositions - Kombinationen
Composicions - Composiciones

CODICE	◆	A	B	C
Z04512008	CL / RO	122	47	48
Z04512009	CL / BG	122	47	48
Z04512010	CL / BN	122	47	48
Z04512011	CL / NR	122	47	48
Z04512508	VT / RO	122	47	48
Z04512509	VT / BG	122	47	48

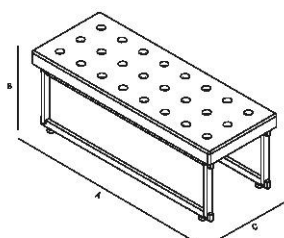

Struttura

Structure / Struktur / Structure / Estructura

CODICE

CODICE	◆
SL99945120510	CL
SL99945120515	VT

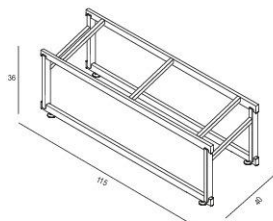

Pouf ecopelle

Stool, synthetic leather
Hocker, Synthetischem Leder
Tabouret, eco-cuir / Taburete, simil-piel

CODICE

CODICE	◆
SL99945120608	RO
SL99945120609	BG
SL99945120610	BN
SL99945120611	NR

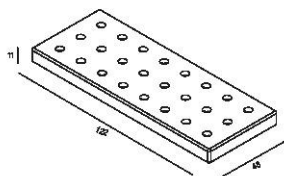

Seduta in ecopelle

Stool, synthetic leather
Hocker aus synthetischem Leder
Tabouret en cuir
Taburete simil piel



Colori sedute

Seat finishing / Sitz-Farben
Couleurs assises / Colores de asientos

RO
Rosso / Red
Rot / Rouge / Rojo



BG
Beige / Beige
Eccru / Écru / Crudo



BN
Bianco / White
Weiss / Blanc / Blanco



NR
Nero / Black
Schwarz / Noir / Negro



Imballo
Packaging
Verpackung
Emballage
Embalaje



zoa seduta curva

Seduta curva in ecopelle

Curved stool, synthetic leather
gebogener Hocker aus synthetischem Leder
Tabouret courbe en cuir
Taburete curvo simil piel



Colori sedute
Seat finishing / Sitz-Farben
Cauleurs assises / Colores de asientos

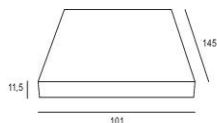

Imballo
Packaging
Verpackung
Emballage
Embalaje

Compositions - Kombinationen
Composicions - Composiciones

CODICE	◆	A	B	C
ZO4514008	CL / RO	149	47	48
ZO4514009	CL / BG	149	47	48
ZO4514010	CL / BN	149	47	48
ZO4514011	CL / NR	149	47	48
ZO4514508	VT / RO	149	47	48
ZO4514509	VT / BG	149	47	48

composizioni

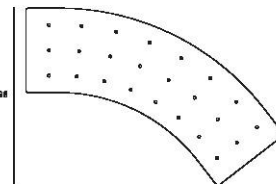

Struttura

Structure / Struktur / Structure / Estructura

CODICE	◆
SL99945140510	CL
SL99945140515	VT

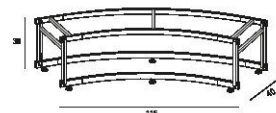

Pouf ecopelle

Stool, synthetic leather
Hocker, Synthetischem Leder
Tabouret, eco-cuir / Taburete, simil-piel

CODICE	◆
SL99945140608	RO
SL99945140609	BG
SL99945140610	BN
SL99945140611	NR

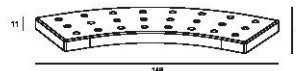



Zoa

Articolo Item Artikel Article Codigo	Descrizione / Description / Beschreibung / Description / Descripcion	CHF - Prezzo unitario - Price per piece - Preis pro Stück - Prix par pièce - Precio para unidad	Confezione Pack Abnahme Unité Unidad
PARETE ATTREZZATA / WALL SYSTEM UNIT / WANDSTRUKTUR / SYSTEME MURALE / PARED EQUIPADA			
ZO33250	Montante per parete attrezzata, CL Upright for wall system unit, CL Säule für Wandstruktur, CL Montant pour système murale, CL Montante para pared equipada, CL	126.00	conf. 2 pz. pack of 2 2 Stück pqt. de 2 paquete de 2
ZO33255	Montante per parete attrezzata, VT Upright for wall system unit, VT Säule für Wandstruktur, VT Montant pour système murale, VT Montante para pared equipada, VT	126.00	conf. 2 pz. pack of 2 2 Stück pqt. de 2 paquete de 2
Accessori per parete attrezzata / Accessories for wall system/ Zubehör für Wandstruktur / Accessoires pour pour système murale / Accesorios para pared equipada			
RO25660	Appenderia a spalla L 66.6 cm, CL Hanging bar L 66.6 cm, CL Konfektionsrahmen L 66.6 cm, CL Guidons penderie L 66.6 cm, CL Barra colgadora L 66.6 cm, CL	19.00	conf. 2 pz. pack of 2 2 Stück pqt. de 2 paquete de 2
RO25665	Appenderia a spalla L 66.6 cm, VT Hanging bar L 66.6 cm, VT Konfektionsrahmen L 66.6 cm, VT Guidons penderie L 66.6 cm, VT Barra colgadora L 66.6 cm, VT	19.00	conf. 2 pz. pack of 2 2 Stück pqt. de 2 paquete de 2
RO25990	Appenderia a spalla L 99.95 cm, CL Hanging bar L 99.95 cm, CL Konfektionsrahmen L 99.95 cm, CL Guidons penderie L 99.95 cm, CL Barra colgadora L 99.95 cm, CL	20.50	conf. 2 pz. pack of 2 2 Stück pqt. de 2 paquete de 2
RO25995	Appenderia a spalla L 99.95 cm, VT Hanging bar L 99.95 cm, VT Konfektionsrahmen L 99.95 cm, VT Guidons penderie L 99.95 cm, VT Barra colgadora L 99.95 cm, VT	20.50	conf. 2 pz. pack of 2 2 Stück pqt. de 2 paquete de 2
RO30660	Barra porta broches L 66.6 cm, CL Display bar L 66.6 cm, CL Konfektionsstange L 66.6 cm, CL Tube penderie L 66.6 cm, CL Barra porta-brazos L 66.6 cm, CL	31.50	conf. 2 pz. pack of 2 2 Stück pqt. de 2 paquete de 2
RO30665	Barra porta broches L 66.6 cm, VT Display bar L 66.6 cm, VT Konfektionsstange L 66.6 cm, VT Tube penderie L 66.6 cm, VT Barra porta-brazos L 66.6 cm, VT	31.50	conf. 2 pz. pack of 2 2 Stück pqt. de 2 paquete de 2
RO30990	Barra porta broches L 99.95 cm, CL Display bar L 99.95 cm, CL Konfektionsstange L 99.95 cm, CL Tube penderie L 99.95 cm, CL Barra porta-brazos L 99.95 cm, CL	32.50	conf. 2 pz. pack of 2 2 Stück pqt. de 2 paquete de 2
RO30995	Barra porta broches L 99.95 cm, VT Display bar L 99.95 cm, VT Konfektionsstange L 99.95 cm, VT Tube penderie L 99.95 cm, VT Barra porta-brazos L 99.95 cm, VT	32.50	conf. 2 pz. pack of 2 2 Stück pqt. de 2 paquete de 2
BA30550	Broche a gradino sezione ovale, CL Stepped arm oval section, CL Abhänger, Stufe - Ovalausschnitt, CL Bras à gradin, section ovale, CL Brazo escalonado seccion ovalada, CL	42.50	1 pz. 1 ea 1 Stück 1 unité 1 unidad

**Zoa**

Articolo Item Artikel Article Codigo	Descrizione / Description / Beschreibung / Déscription/ Descripcion	CHF - Prezzo unitario - Price per piece - Preis pro Stück - Prix par pièce - Precio para unidad	Confezione Pack Abnahme Unité Unidad
BA30555	Broche a gradino sezione ovale, VT Stepped arm oval section, VT Abhänger, Stufe - Ovalausschnitt, VT Bras à gradin, section ovale, VT Brazo escalonado seccion ovalada, VT	42.50	1 pz. 1 ea 1 Stück 1 unité 1 unidad
BA20360	Broche dritta sezione ovale L 36 cm, CL Straight arm oval section L 36 cm, CL Abhänger, gerade - Ovalausschnitt L 36 cm, CL Bras droit, section oval L 36 cm, CL Brazo recto seccion ovalada L 36 cm, CL	14.00	1 pz. 1 ea 1 Stück 1 unité 1 unidad
BA20365	Broche dritta sezione ovale L 36 cm, VT Straight arm oval section L 36 cm, VT Abhänger, gerade - Ovalausschnitt L 36 cm, VT Bras droit, section oval L 36 cm, VT Brazo recto seccion ovalada L 36 cm, VT	14.00	1 pz. 1 ea 1 Stück 1 unité 1 unidad
BA30420	Broche inclinata sezione ovale L 45 cm, CL Sloping arm oval section L 45 cm, CL Abhänger, schräg - Ovalausschnitt L 45 cm, CL Bras incliné, section oval L 45 cm, CL Brazo inclinado seccion oval L 45 cm, CL	17.00	1 pz. 1 ea 1 Stück 1 unité 1 unidad
BA30425	Broche inclinata sezione ovale L 45 cm, VT Sloping arm oval section L 45 cm, VT Abhänger, schräg - Ovalausschnitt L 45 cm, VT Bras incliné, section oval L 45 cm, VT Brazo inclinado seccion oval L 45 cm, VT	17.00	1 pz. 1 ea 1 Stück 1 unité 1 unidad
BA30280	Supporti per barra appenderia, CL Bust support for hanging bar, CL Büstenhalter für Konfektionsrahmen, CL Support buste pour barre penderie, CL Soportes para barra colgadora, CL	16.00	1 pz. 1 ea 1 Stück 1 unité 1 unidad
ZO50290	Coppia mensola, CL Shelf brackets (pair), CL Konsole, mitting - Paar, CL Consoles (la paire), CL Cartelas, CL	12.50	conf. 5 pz. pack of 5 5 Stück pqt. de 5 paquete de 5
ZO50295	Coppia mensola, VT Shelf brackets (pair), VT Konsole, mitting - Paar, VT Consoles (la paire), VT Cartelas, VT	12.50	conf. 5 pz. pack of 5 5 Stück pqt. de 5 paquete de 5
ZO30600	Barra appenderia per sotto-ripiano L 67 cm, CL Hanging bar for shelf L 67 cm, CL Konfektionsstange L 67 cm, CL Barre penderie avec fixation pour tablette L 67 cm, CL Barra colgadora para estante L 67 cm, CL	17.50	conf. 2 pz. pack of 2 2 Stück pqt. de 2 paquete de 2
ZO30605	Barra appenderia per sotto-ripiano L 67 cm, VT Hanging bar for shelf L 67 cm, VT Konfektionsstange L 67 cm, VT Barre penderie avec fixation pour tablette L 67 cm, VT Barra colgadora para estante L 67 cm, VT	17.50	conf. 2 pz. pack of 2 2 Stück pqt. de 2 paquete de 2
ZO30970	Barra appenderia per sotto-ripiano L 100 cm, CL Hanging bar for shelf L 100 cm, CL Konfektionsstange L 100 cm, CL Barre penderie avec fixation pour tablette L 100 cm, CL Barra colgadora para estante L 100 cm, CL	19.00	conf. 2 pz. pack of 2 2 Stück pqt. de 2 paquete de 2
ZO30975	Barra appenderia per sotto ripiano L 100 cm, VT Hanging bar for shelf L 100 cm, VT Konfektionsstange L 100 cm, VT Barre penderie avec fixation pour tablette L 100 cm, VT Barra colgadora para estante L 100 cm, VT	19.00	conf. 2 pz. pack of 2 2 Stück pqt. de 2 paquete de 2
ZO37640	Supporto per ripiano in cristallo L 67 cm, CL Glass shelf support L 67 cm, CL Glasbodenträger L 67 cm, CL Support pour tablette en verre L 67 cm, CL Soporte para estante en cristal L 67 cm, CL	32.50	1 pz. 1 ea 1 Stück 1 unité 1 unidad
ZO37645	Supporto per ripiano in cristallo L 67 cm, VT Glass shelf support L 67 cm, VT Glasbodenträger L 67 cm, VT Support pour tablette en verre L 67 cm, VT Soporte para estante en cristal L 67 cm, VT	32.50	1 pz. 1 ea 1 Stück 1 unité 1 unidad

DITTA DISPLAYinfo@dittadisplay.ch
1, www.dittadisplay.chTEL 021 691 12 12 FAX 021 691 13 13
TEL 043 495 06 61 FAX 043 495 06 62Ch. des Champs-Courbes 1,
ZI En Vallaire Est, 1024 Ecublens VD 26

**Zoa**

Articolo Item Artikel Article Codigo	Descrizione / Description / Beschreibung / Déscription/ Descripcion	CHF - Prezzo unitario - Price per piece - Preis pro Stück - Prix par pièce - Precio para unidad	Confezione Pack Abnahme Unité Unidad
ZO37970	Supporto per ripiano in cristallo L 100 cm, CL Glass shelf support L 100 cm, CL Glasbodenträger L 100 cm, CL Support pour tablette en verre L 100 cm, CL Soporte para estante en cristal L 100 cm, CL	37.50	1 pz. 1 ea 1 Stück 1 unité 1 unidad
ZO37975	Supporto per ripiano in cristallo L 100 cm, VT Glass shelf support L 100 cm, VT Glasbodenträger L 100 cm, VT Support pour tablette L 100 cm, VT Soporte para estante en cristal L 100 cm, VT	37.50	1 pz. 1 ea 1 Stück 1 unité 1 unidad
Ripiani / Shelves / Boden / Tablettes / Estantes			
RO186440007	Ripiano 64x40 cm, rovere sbiancato Shelf 64x40 cm, light oak Boden 64x40 cm, Helleiche Tablette 64x40 cm, rouvre claire Estante 64x40 cm, roble blanqueado	20.50	conf. 5 pz. pack of 5 5 Stück pqt. de 5 caja de 5
ZO6440018009	Ripiano 64x40 cm, bianco Shelf 64x40 cm, white Boden 64x40 cm, weiss Tablette 64x40 cm, blanc Estante 64x40 cm, blanco	20.50	conf. 5 pz. pack of 5 5 Stück pqt. de 5 caja de 5
RO08640400	Ripiano 64 x 40 x 0.8 cm, cristallo temprato acidato Shelf 64 x 40 x 0.8 cm, matt tempered glass Boden 64 x 40 x 0.8 cm, matt gehärteter Kristall Tablette 64 x 40 x 0.8 cm, verre trempé sablé Estante 64 x 40 x 0.8 cm, cristal templado satinado	44.00	conf. 2 pz. pack of 2 2 Stück pqt. de 2 caja de 2
ZO9740018007	Ripiano 97x40 cm, rovere sbiancato Shelf 97x40 cm, light oak Boden 97x40 cm, Helleiche Tablette 97x40 cm, rouvre claire Estante 97x40 cm, roble blanqueado	35.50	conf. 5 pz. pack of 5 5 Stück pqt. de 5 caja de 5
ZO9740018009	Ripiano 97x40 cm, bianco Shelf 97x40 cm, white Boden 97x40 cm, weiss Tablette 97x40 cm, blanc Estante 97x40 cm, blanco	35.50	conf. 5 pz. pack of 5 5 Stück pqt. de 5 caja de 5
ZO97240008	Ripiano 97 x 40 x 0.8 cm, cristallo temprato acidato Shelf 97 x 40 x 0.8 cm, matt tempered glass Boden 97 x 40 x 0.8 cm, matt gehärteter Kristall Tablette 97 x 40 x 0.8 cm, verre trempé sablé Estante 97 x 40 x 0.8 cm, cristal templado satinado	69.00	conf. 2 pz. pack of 2 2 Stück pqt. de 2 caja de 2
GONDOLA / GONDOLA / GONDEL / GONDOLE / GONDOLA			
Struttura / Structure / Struktur / Structure / Estructura			
ZO15540	Struttura gondola 100 cm, CL Gondola structure 100 cm, CL Gondelstruktur 100 cm, CL Structure gondole 100 cm, CL Estructura góndola 100 cm, CL	319.00	1 pz. 1 ea 1 Stück 1 unité 1 unidad
ZO15545	Struttura gondola 100 cm, VT Gondola structure 100 cm, VT Gondelstruktur 100 cm, VT Structure gondole 100 cm, VT Estructura góndola 100 cm, VT	319.00	1 pz. 1 ea 1 Stück 1 unité 1 unidad
Accessori per gondola / Accessories for gondola / Zubehör für Gondel / Accessoires pour gondole / Accesorios para góndola			
GO20390	Coppia mensola, CL Shelf brackets (pair), CL Konsole, mitting - Paar, CL Consoles (la paire), CL Cartelas, CL	12.00	conf. 5 pz. pack of 5 5 Stück pqt. de 5 caja de 5
GO20395	Coppia mensola, VT Shelf brackets (pair), VT Konsole, mitting - Paar, VT Consoles (la paire), VT Cartelas, VT	12.00	conf. 5 pz. pack of 5 5 Stück pqt. de 5 caja de 5
GO2039020	Supporto per ripiano in cristallo da 100x40 cm, CL Support for glass shelf 100x40 cm, CL Kristalldodenträger 100x40 cm, CL Support pour tablette en glace 100x40 cm, CL Soporte para estante en cristal 100x40cm, CL	32.00	conf. 2 pz. pack of 2 2 Stück pqt. de 2 caja de 2

**Zoa**

Articolo Item Artikel Article Codigo	Descrizione / Description / Beschreibung / Déscription/ Descripcion	CHF - Prezzo unitario - Price per piece - Preis pro Stück - Prix par pièce - Precio para unidad	Confezione Pack Abnahme Unité Unidad
GO2039025	Supporto per ripiano in cristallo da 100x40 cm, VT Support for glass shelf 100x40 cm, VT Kristalldodenträger 100x40 cm, VT Support pour tablette en glace 100x40 cm, VT Soporte para estante en cristal 100x40cm, VT	32.00	conf. 2 pz. pack of 2 2 Stück pqt. de 2 caja de 2
GO2039020	Supporto per ripiano in cristallo da 100x40 cm, CL Support for glass shelf 100x40 cm, CL Kristalldodenträger 100x40 cm, CL Support pour tablette en glace 100x40 cm, CL Soporte para estante en cristal 100x40cm, CL	32.00	conf. 2 pz. pack of 2 2 Stück pqt. de 2 caja de 2
GO2039025	Supporto per ripiano in cristallo da 100x40 cm, VT Support for glass shelf 100x40 cm, VT Kristalldodenträger 100x40 cm, VT Support pour tablette en glace 100x40 cm, VT Soporte para estante en cristal 100x40cm, VT	32.00	conf. 2 pz. pack of 2 2 Stück pqt. de 2 caja de 2
BA30550	Broche a gradino, CL Stepped arm, CL Stufenabhängung, CL Bras à gradin, CL Brazo escalonado, CL	42.50	1 pz. 1 ea 1 Stück 1 unité 1 unidad
BA30555	Broche a gradino, VT Stepped arm, VT Stufenabhängung, VT Bras à gradin, VT Brazo escalonado, VT	42.50	1 pz. 1 ea 1 Stück 1 unité 1 unidad
BA20360	Broche dritta da 38 cm, CL Straight arm 38 cm, CL Gerade Frontabhängung 38 cm, CL Bras droit 38 cm, CL Brazo recto 38 cm, CL	14.00	1 pz. 1 ea 1 Stück 1 unité 1 unidad
BA20365	Broche dritta da 38 cm, VT Straight arm 38 cm, VT Gerade Frontabhängung 38 cm, VT Bras droit 38 cm, VT Brazo recto 38 cm, VT	14.00	1 pz. 1 ea 1 Stück 1 unité 1 unidad
BA30420	Broche inclinata da 45 cm, CL Sloping Arm 45 cm, CL Schräge Frontabhängung 45 cm, CL Bras incliné 45 cm, CL Brazo inclinado 45 cm, CL	17.00	1 pz. 1 ea 1 Stück 1 unité 1 unidad
BA30425	Broche inclinata da 45 cm, VT Sloping Arm 45 cm, VT Schräge Frontabhängung 45 cm, VT Bras incliné 45 cm, VT Brazo inclinado 45 cm, VT	17.00	1 pz. 1 ea 1 Stück 1 unité 1 unidad
BA30660	Appenderia a spalla da 67x30 cm, CL Straight Hanging Rail 67x30 cm, CL Konfektionsrahmen 67x30 cm, CL Guidons penderie 67x30 cm, CL Barra colgadora 67x30 cm, CL	21.50	conf. 2 pz. pack of 2 2 Stück pqt. de 2 caja de 2
BA30665	Appenderia a spalla da 67x30 cm, VT Straight Hanging Rail 67x30 cm, VT Konfektionsrahmen 67x30 cm, VT Guidons penderie 67x30 cm, VT Barra colgadora 67x30 cm, VT	21.50	conf. 2 pz. pack of 2 2 Stück pqt. de 2 caja de 2
BA301000	Appenderia a spalla da 100x30 cm, CL Straight Hanging Rail 100x30 cm, CL Konfektionsrahmen 100x30 cm, CL Guidons penderie 100x30 cm, CL Barra colgadora 100x30 cm, CL	23.50	conf. 2 pz. pack of 2 2 Stück pqt. de 2 caja de 2
BA301005	Appenderia a spalla da 100x30 cm, VT Straight Hanging Rail 100x30 cm, VT Konfektionsrahmen 100x30 cm, VT Guidons penderie 100x30 cm, VT Barra colgadora 100x30 cm, VT	23.50	conf. 2 pz. pack of 2 2 Stück pqt. de 2 caja de 2
BA30670	Ripiano in griglia da 67x30 cm, CL Grid shelf 67x30 cm, CL Gitterboden 67x30 cm, CL Tablette en grille 67x30 cm, CL Estante reja 67x30 cm, CL	28.00	conf. 5 pz. pack of 5 5 Stück pqt. de 5 caja de 5

DITTA DISPLAYinfo@dittadisplay.ch
1, www.dittadisplay.chTEL 021 691 12 12 FAX 021 691 13 13
TEL 043 495 06 61 FAX 043 495 06 62Ch. des Champs-Courbes 1,
ZI En Vallaire Est, 1024 Ecublens VD 28

**Zoa**

Articolo Item Artikel Article Codigo	Descrizione / Description / Beschreibung / Déscription/ Descripcion	CHF - Prezzo unitario - Price per piece - Preis pro Stück - Prix par pièce - Precio para unidad	Confezione Pack Abnahme Unité Unidad
BA30990	Ripiano in griglia da 100x30, CL Grid shelf 100x30 cm, CL Gitterboden 100x30 cm, CL Tablette en grille 100x30 cm, CL Estante reja 100x30 cm, CL	34.00	conf. 5 pz. pack of 5 5 Stück pqt. de 5 caja de 5
BA20660	Barra porta broche da 67 cm, CL Display bar 67 cm, CL Konfektionsstange 67 cm, CL Barre de charge 67 cm, CL Barra porta brazos 67 cm, CL	16.00	conf. 2 pz. pack of 2 2 Stück pqt. de 2 caja de 2
BA20665	Barra porta broche da 67 cm, VT Display bar 67 cm, VT Konfektionsstange 67 cm, VT Barre de charge 67 cm, VT Barra porta brazos 67 cm, VT	16.00	conf. 2 pz. pack of 2 2 Stück pqt. de 2 caja de 2
BA20990	Barra porta broche da 100 cm, CL Display bar 100 cm, CL Konfektionsstange 100 cm, CL Barre de charge 100 cm, CL Barra porta brazos 100 cm, CL	17.50	conf. 2 pz. pack of 2 2 Stück pqt. de 2 caja de 2
BA20995	Barra porta broche da 100 cm, VT Display bar 100 cm, VT Konfektionsstange 100 cm, VT Barre de charge 100 cm, VT Barra porta brazos 100 cm, VT	17.50	conf. 2 pz. pack of 2 2 Stück pqt. de 2 caja de 2
GO40660	Ripiano in lamiera forata da 67x40 cm, cromo lucido Perforated shelf 67x40 cm, chrome Lochblechfachboden 67x40 cm, verchromt Tablette perforée 67x40 cm, chromé Estante perforado 67x40 cm, cromado	64.00	1 pz. 1 ea 1 Stück 1 unité 1 unidad
GO40990	Ripiano in lamiera forata da 100x40 cm, cromo lucido Perforated shelf 100x40 cm, chrome Lochblechfachboden 100x40 cm, verchromt Tablette perforée 100x40 cm, chromé Estante perforado 100x40 cm, cromado	76.00	1 pz. 1 ea 1 Stück 1 unité 1 unidad
Ripiani / Shelves / Boden / Tablettes / Estantes			
GO200664007	Ripiano da 67x40x1,8 cm, rovere sbiancato Shelf 67x40x1,8 cm, light oak Boden 67x40x1,8 cm, Helleiche Tablette 67x40x1,8 cm, rouvre claire Estante 67x40x1,8 cm, roble claro	20.50	conf. 5 pz. pack of 5 5 Stück pqt. de 5 caja de 5
GO200664009	Ripiano da 67x40x1,8 cm, bianco Shelf 67x40x1,8 cm, white Boden 67x40x1,8 cm, weiss Tablette 67x40x1,8 cm, blanc Estante 67x40x1,8 cm, blanco	20.50	conf. 5 pz. pack of 5 5 Stück pqt. de 5 caja de 5
GO200994007	Ripiano da 100x40x1,8 cm, rovere sbiancato Shelf 100x40x1,8 cm, light oak Boden 100x40x1,8 cm, Helleiche Tablette 100x40x1,8 cm, rouvre claire Estante 100x40x1,8 cm, roble claro	29.00	conf. 5 pz. pack of 5 5 Stück pqt. de 5 caja de 5
GO200994009	Ripiano da 100x40x1,8 cm, bianco Shelf 100x40x1,8 cm, white Boden 100x40x1,8 cm, weiss Tablette 100x40x1,8 cm, blanc Estante 100x40x1,8 cm, blanco	29.00	conf. 5 pz. pack of 5 5 Stück pqt. de 5 caja de 5
GO250664007	Ripiano da 67x40x2,5 cm, rovere sbiancato Shelf 67x40x2,5 cm, light oak Boden 67x40x2,5 cm, Helleiche Tablette 67x40x2,5 cm, rouvre claire Estante 67x40x2,5 cm, roble claro	29.00	conf. 5 pz. pack of 5 5 Stück pqt. de 5 caja de 5
GO250664009	Ripiano da 67x40x2,5 cm, bianco Shelf 67x40x2,5 cm, white Boden 67x40x2,5 cm, weiss Tablette 67x40x2,5 cm, blanc Estante 67x40x2,5 cm, blanco	29.00	conf. 5 pz. pack of 5 5 Stück pqt. de 5 caja de 5
GO251004007	Ripiano da 100x40x2,5 cm, rovere sbiancato Shelf 100x40x2,5 cm, light oak Boden 100x40x2,5 cm, Helleiche Tablette 100x40x2,5 cm, rouvre claire Estante 100x40x2,5 cm, roble claro	36.00	conf. 5 pz. pack of 5 5 Stück pqt. de 5 caja de 5

DITTA DISPLAYinfo@dittadisplay.ch
1, www.dittadisplay.chTEL 021 691 12 12 FAX 021 691 13 13
TEL 043 495 06 61 FAX 043 495 06 62Ch. des Champs-Courbes 1,
ZI En Vallaire Est, 1024 Ecublens VD 29

**Zoa**

Articolo Item Artikel Article Codigo	Descrizione / Description / Beschreibung / Descripción/ Descripcion	CHF - Prezzo unitario - Price per piece - Preis pro Stück - Prix par pièce - Precio para unidad	Confezione Pack Abnahme Unité Unidad
GO251004009	Ripiano da 100x40x2,5 cm, bianco Shelf 100x40x2,5 cm, white Boden 100x40x2,5 cm, weiss Tablette 100x40x2,5 cm, blanc Estante 100x40x2,5 cm, blanco	36.00	conf. 5 pz. pack of 5 5 Stück pqt. de 5 caja de 5
GO08376600	Ripiano in cristallo temperato acidato da 67x40x0,8 cm Matt tempered glass shelf 67x40x0,8 cm Gehärteter Kristallboden 67x40x0,8 cm Tablette en glace tempré acidé 67x40x0,8 cm Estante en cristal templado opaco 67x40x0,8 cm	55.00	1 pz. 1 ea 1 Stück 1 unité 1 unidad
GO08379900	Ripiano in cristallo temperato acidato da 100x40x0,8 cm Matt tempered glass shelf 100x40x0,8 cm Gehärteter Kristallboden 100x40x0,8 cm Tablette en glace tempré acidé 100x40x0,8 cm Estante en cristal templado opaco 100x40x0,8 cm	78.00	1 pz. 1 ea 1 Stück 1 unité 1 unidad
STENDER / GARMENT RAIL / STAENDER / PENDERIE / PERCHERO			
ZO58160	Stender, CL Garment rail, CL Ständer, CL Penderie, CL Perchero, CL	191.00	1 pz. 1 ea 1 Stück 1 unité 1 unidad
ZO58165	Stender, VT Garment rail, VT Ständer, VT Penderie, VT Perchero, VT	191.00	1 pz. 1 ea 1 Stück 1 unité 1 unidad
STENDER CURVO / CURVED GARMENT RAIL / BOGENFÖRMIGER STAENDER / PENDERIE COURBE / PERCHERO CURVO			
ZO58150	Stender curvo, CL Curved garment rail, CL Bogenförmiger Ständer, CL Penderie courbe, CL Perchero curvo, CL	198.00	1 pz. 1 ea 1 Stück 1 unité 1 unidad
ZO58155	Stender curvo, VT Curved garment rail, VT Bogenförmiger Ständer, VT Penderie courbe, VT Perchero curvo, VT	198.00	1 pz. 1 ea 1 Stück 1 unité 1 unidad
STENDER SEMICIRCOLARE / SEMICIRCULAR RAIL / STÄNDER HALBRUNDEN / PENDERIE SEMI-CIRCULAIRE / PERCHERO SEMICIRCULAR			
ZO58120	Stender Semicircolare, CL Semicircular Rail, CL Ständer halbrunden, CL Penderie semi-circulaire, CL Perchero semicircular, CL	269.00	1 pz. 1 ea 1 Stück 1 unité 1 unidad
STENDER SWING			
ZO58175P09	Stender, SWING VT / BN Garment rail SWING, VT / BN Ständer SWING, VT / BN Penderie SWING, VT / BN Perchero SWING, VT / BN	314.00	1 pz. 1 ea 1 Stück 1 unité 1 unidad
ZO58175P01	Stender, SWING VT / NO Garment rail SWING, VT / NO Ständer SWING, VT / NO Penderie SWING, VT / NO Perchero SWING, VT / NO	369.00	1 pz. 1 ea 1 Stück 1 unité 1 unidad
ZO18645609	Ripiano bianco da 64x56x1,8 cm, BN White Shelf 64x56x1,8 cm, BN Weiss Fachböden 64x56x1,8 cm, BN Tablette Blanc 64x56x1,8 cm, BN Estante Blanco 64x56x1,8 cm, BN	34.50	1 pz. 1 ea 1 Stück 1 unité 1 unidad



Zoa

Articolo Item Artikel Article Codigo	Descrizione / Description / Beschreibung / Déscription/ Descripcion	CHF - Prezzo unitario - Price per piece - Preis pro Stück - Prix par pièce - Precio para unidad	Confezione Pack Abnahme Unité Unidad
ZO18645601	Ripiano nero ossidato da 64x56x1,8 cm, NO Black Oxidized Shelf 64x56x1,8 cm, NO Schwarz Oxidized Fachböden 64x56x1,8 cm, NO Tablette Oxydé Noir 64x56x1,8 cm, NO Estante Negro Oxidado 64x56x1,8 cm, NO	89.00	1 pz. 1 ea 1 Stück 1 unité 1 unidad
ESPOSITORE A 3 PIANI / 3-TIER DISPLAY UNIT / MITTELRAUMELEMENT, 3-STUFIG / PRESENTOIR 3 NIVEAUX / ESPOSITOR ESCALONADO			
Struttura / Structure / Struktur / Structure / Estructura			
ZO54100	Struttura espositore a 3 piani, CL Structure for 3-tier display unit, CL Struktur für Mittelraumelement, 3-stufig, CL Structure pour présentoir 3 niveaux, CL Estructura para espositor escalonado, CL	397.00	1 pz. 1 ea 1 Stück 1 unité 1 unidad
ZO54105	Struttura espositore a 3 piani, VT Structure for 3-tier display unit, VT Struktur für Mittelraumelement, 3-stufig, VT Structure pour présentoir 3 niveaux, VT Estructura para espositor escalonado, VT	397.00	1 pz. 1 ea 1 Stück 1 unité 1 unidad
Ripiani / Shelves / Böden / Tablettes / Estantes			
ZO5410007	Ripiani (set 5 pz), rovere sbiancato Shelves (pack of 5), light oak Böden (VPE: 5 Stück), Helleiche Tablettes (pqt. de 5), rouvre claire Estantes (caja de 5), roble blanqueado	201.00	1 pz. 1 ea 1 Stück 1 unité 1 unidad
ZO5410009	Ripiani (set 5 pz.), bianco Shelves (pack of 5), white Böden (VPE: 5 Stück), weiss Tablettes (pqt. de 5), blanc Estantes (caja de 5), blanco	201.00	1 pz. 1 ea 1 Stück 1 unité 1 unidad
BANCO ESPOSITIVO / DISPLAY TABLE / VORLAGENTISCH / COMPTOIR / MOSTRADOR			
Composizioni / Compositions / Kombinationen / Compositions / Composiciones			
ZO5411007	Banco espositivo , cromo lucido/cristallo temp. trasp./rovere sbiancato Display table, chrome finishing/transp. tempered glass/light oak Vorlagetisch, verchromt/gehärtetes Kristall-Klarglass/Helleiche Comptoir, chromée/verre trempé claire/rouvre claire Mostrador, cromado/vidrio templado transparente/roble blanqueado	545.00	1 pz. 1 ea 1 Stück 1 unité 1 unidad
ZO5411009	Banco espositivo, cromo lucido/cristallo temp. trasp./bianco Display table, chrome finishing/transp. tempered glass/white Vorlagetisch, verchromt/gehärtetes Kristall-Klarglass/weiss Comptoir, chromée/verre trempé claire/blanc Mostrador, cromado/vidrio templado transparente/blanco	545.00	1 pz. 1 ea 1 Stück 1 unité 1 unidad
ZO5411507	Banco espositivo, verniciato trasp./cristallo temp. trasp./rovere sbiancato Display table, transp. paint/transp. tempered glass/light oak Vorlagetisch, Transp. lackiert/gehärtetes Kristall-Klarglass/Helleiche Comptoir, métal verni transp./verre trempé claire/rouvre claire Mostrador, pintado trasp./vidrio templado transparente/roble blanqueado	545.00	1 pz. 1 ea 1 Stück 1 unité 1 unidad
ZO5411509	Banco espositivo, verniciato trasp./cristallo temp. trasp./bianco Display table, transp. paint/transp. tempered glass/white Vorlagetisch, Transp. lackiert/gehärtetes Kristall-Klarglass/weiss Comptoir, métal verni transp./verre trempé claire/blanc Mostrador, pintado trasp./vidrio templado transparente/blanco	545.00	1 pz. 1 ea 1 Stück 1 unité 1 unidad
Struttura / Structure / Struktur / Structure / Estructura			
ZO54110	Struttura banco espositivo, CL Structure display table, CL Struktur für Vorlagentisch, CL Structure pour comptoir, CL Estructura para mostrador, CL	369.00	1 pz. 1 ea 1 Stück 1 unité 1 unidad
ZO54115	Struttura banco espositivo, VT Structure display table, VT Struktur für Vorlagentisch, VT Structure pour comptoir, VT Estructura para mostrador, VT	369.00	1 pz. 1 ea 1 Stück 1 unité 1 unidad
Piano / Shelf / Boden / Tablette / Estante			



Zoa

Articolo Item Artikel Article Codigo	Descrizione / Description / Beschreibung / Déscription/ Descripcion	CHF - Prezzo unitario - Price per piece - Preis pro Stück - Prix par pièce - Precio para unidad	Confezione Pack Abnahme Unité Unidad
ZO181286507	Piano per banco espositivo in rovere sbiancato Shelf for display table light oak Boden für Vorlagetisch Helleiche Tablette pour comptoir rouvre claire Estante para mostrador roble blanqueado	61.00	1 pz. 1 ea 1 Stück 1 unité 1 unidad
ZO181286509	Piano per banco espositivo, bianco Shelf for display table, white Boden für Vorlagetisch, weiss Tablette pour comptoir, blanc Estante para mostrador, blanco	61.00	1 pz. 1 ea 1 Stück 1 unité 1 unidad
VS350M137005	Piano per banco espositivo in cristallo temprato trasparente Shelf for display table transp. tempered glass Boden für Vorlagetisch gehärtetes Kristall-Klarglass Tablette pour comptoir verre trempé claire Estante para mostrador vidrio templado transparente	139.00	1 pz. 1 ea 1 Stück 1 unité 1 unidad
VS350M137000	Piano per banco espositivo in cristallo temprato acidato Shelf for display table, matt tempered glass Boden für Vorlagetisch, Matt gehärtetes Kristall Tablette pour comptoir, matt verre trempé Estante para mostrador vidrio templado satinado	160.00	1 pz. 1 ea 1 Stück 1 unité 1 unidad
SEDUTA IN ECOPELLE / STOOL, SYNTHETIC LEATHER / HOCKER AUS SYNTHETISCHEM LEDER / TABOURET EN CUIR / TABURETE SIMIL PIEL			
ZO4512008	Seduta CL/rosso Stool CL/red Hocker CL/rot Tabouret CL/rouge Taburete CL/rojo	468.00	1 pz. 1 ea 1 Stück 1 unité 1 unidad
ZO4512009	Seduta CL/beige Stool CL/oatmeal Hocker CL/ecru Tabouret CL/écru Taburete CL/crudo	468.00	1 pz. 1 ea 1 Stück 1 unité 1 unidad
ZO4512010	Seduta CL/bianco Stool CL/white Hocker CL/weiss Tabouret CL/blanc Taburete CL/blanco	468.00	1 pz. 1 ea 1 Stück 1 unité 1 unidad
ZO4512011	Seduta CL/nero Stool CL/black Hocker CL/schwarz Tabouret CL/noir Taburete CL/negro	468.00	1 pz. 1 ea 1 Stück 1 unité 1 unidad
ZO4512508	Seduta VT/rosso Stool VT/red Hocker, VT/rot Tabouret VT/rouge Taburete VT/rojo	468.00	1 pz. 1 ea 1 Stück 1 unité 1 unidad
ZO4512509	Seduta VT/beige Stool VT/oatmeal Hocker, VT/ecru Tabouret VT/écru Taburete VT/crudo	468.00	1 pz. 1 ea 1 Stück 1 unité 1 unidad
SL99945120510	Struttura seduta CL Stool structure, CL Hockerstruktur, CL Structure Tabouret, CL Estructura Taburete, CL	326.00	1 pz. 1 ea 1 Stück 1 unité 1 unidad
SL99945120515	Struttura seduta VT Stool structure, VT Hockerstruktur, VT Structure Tabouret, VT Estructura Taburete, VT	326.00	1 pz. 1 ea 1 Stück 1 unité 1 unidad
SL99945120608	Pouf ecopelle, rosso Stool, red synthetic leather Hocker, rot Syntethischem Leder Tabouret, eco-cuir rouge Taburete, simil-piel rojo	170.00	1 pz. 1 ea 1 Stück 1 unité 1 unidad
SL99945120609	Pouf ecopelle, beige Stool, oatmeal synthetic leather Hocker, ecru Syntethischem Leder Tabouret, eco-cuir écru Taburete, simil-piel crudo	170.00	1 pz. 1 ea 1 Stück 1 unité 1 unidad

DITTA DISPLAY

info@dittadisplay.ch
1, www.dittadisplay.ch

TEL 021 691 12 12 FAX 021 691 13 13
TEL 043 495 06 61 FAX 043 495 06 62

Ch. des Champs-Courbes 1,
ZI En Vallaire Est, 1024 Ecublens VD 32

**Zoa**

Articolo Item Artikel Article Codigo	Descrizione / Description / Beschreibung / Descripción/ Descripcion	CHF - Prezzo unitario - Price per piece - Preis pro Stück - Prix par pièce - Precio para unidad	Confezione Pack Abnahme Unité Unidad
SL99945120610	Pouf ecopelle, bianco Stool, white synthetic leather Hocker, weiss Syentheticchem Leder Tabouret, eco-cuir blanc Taburete, simil-piel blanco	170.00	1 pz. 1 ea 1 Stück 1 unité 1 unidad
SL99945120611	Pouf ecopelle, nero Stool, black synthetic leather Hocker, schwarz Syentheticchem Leder Tabouret, eco-cuir noir Taburete, simil-piel negro	170.00	1 pz. 1 ea 1 Stück 1 unité 1 unidad
SEDUTA CURVA IN ECOPELLE / CURVED STOOL, SYNTHETIC LEATHER GEBOGENER HOCKER AUS SYNTHETISCHEM LEDER / TABOURET COURBE EN CUIR / TABURETE CURVO SIMIL PIEL			
ZO4514008	Seduta curva CL/rosso Curved stool CL/red Gebogener Hocker CL/rot Tabouret courbe CL/rouge Taburete curvo, CL/rojo	510.00	1 pz. 1 ea 1 Stück 1 unité 1 unidad
ZO4514009	Seduta curva CL/beige Curved stool CL/oatmeal Gebogener Hocker CL/ecru Tabouret courbe CL/ecru Taburete curvo, CL/crudo	510.00	1 pz. 1 ea 1 Stück 1 unité 1 unidad
ZO4514010	Seduta curva CL/bianco Curved stool CL/white Gebogener Hocker CL/weiss Tabouret courbe CL/blanc Taburete curvo, CL/blanco	510.00	1 pz. 1 ea 1 Stück 1 unité 1 unidad
ZO4514011	Seduta curva CL/nero Curved stool CL/black Gebogener Hocker CL/schwarz Tabouret courbe CL/noir Taburete curvo, CL/negro	510.00	1 pz. 1 ea 1 Stück 1 unité 1 unidad
ZO4514508	Seduta curva VT/rosso Curved stool VT/red Gebogener Hocker, VT/rot Tabouret courbe VT/rouge Taburete curvo, VT/rojo	510.00	1 pz. 1 ea 1 Stück 1 unité 1 unidad
ZO4514509	Seduta curva VT/beige Curved stool VT/oatmeal Gebogener Hocker, VT/ecru Tabouret courbe VT/ecru Taburete curvo, VT/crudo	510.00	1 pz. 1 ea 1 Stück 1 unité 1 unidad
SL99945140510	Struttura seduta CL Stool structure, CL Hockerstruktur, CL Structure Tabouret, CL Estructura Taburete, CL	347.00	1 pz. 1 ea 1 Stück 1 unité 1 unidad
SL99945140515	Struttura seduta VT Stool structure, VT Hockerstruktur, VT Structure Tabouret, VT Estructura Taburete, VT	347.00	1 pz. 1 ea 1 Stück 1 unité 1 unidad
SL99945140608	Pouf ecopelle, rosso Stool, red synthetic leather Hocker, rot Syentheticchem Leder Tabouret, eco-cuir rouge Taburete, simil-piel rojo	191.00	1 pz. 1 ea 1 Stück 1 unité 1 unidad
SL99945140609	Pouf ecopelle, beige Stool, oatmeal synthetic leather Hocker, ecru Syentheticchem Leder Tabouret, eco-cuir é cru Taburete, simil-piel crudo	191.00	1 pz. 1 ea 1 Stück 1 unité 1 unidad
SL99945140610	Pouf ecopelle, bianco Stool, white synthetic leather Hocker, weiss Syentheticchem Leder Tabouret, eco-cuir blanc Taburete, simil-piel blanco	191.00	1 pz. 1 ea 1 Stück 1 unité 1 unidad
SL99945140611	Pouf ecopelle, nero Stool, black synthetic leather Hocker, schwarz Syentheticchem Leder Tabouret, eco-cuir noir Taburete, simil-piel negro	191.00	1 pz. 1 ea 1 Stück 1 unité 1 unidad

Preise ab unseren Lokalitäten. Preisänderung vorbehalten.
Diese Preisliste annulliert die vorhergehende.
Lieferfrist ca. 4 Wochen ab Auftragsbestätigung. **Exkl. MwSt**
Fotos, Farben und Grössen können vom Original abweichen.

Prix départ de nos locaux. Sous réserve de modifications. **TVA non incluse**
La présente liste annule et remplace toute précédente liste.
Délai de livraison hors stock, env. 4 sem. dès confirmation commande.
Photos, couleurs et mesures non contractuelles.

DITTA DISPLAY

info@dittadisplay.ch
1, www.dittadisplay.ch

TEL 021 691 12 12 FAX 021 691 13 13
TEL 043 495 06 61 FAX 043 495 06 62

Ch. des Champs-Courbes 1,
ZI En Vallaire Est, 1024 Ecublens VD 33