

↓ New
Prices

SlatBoard[®]

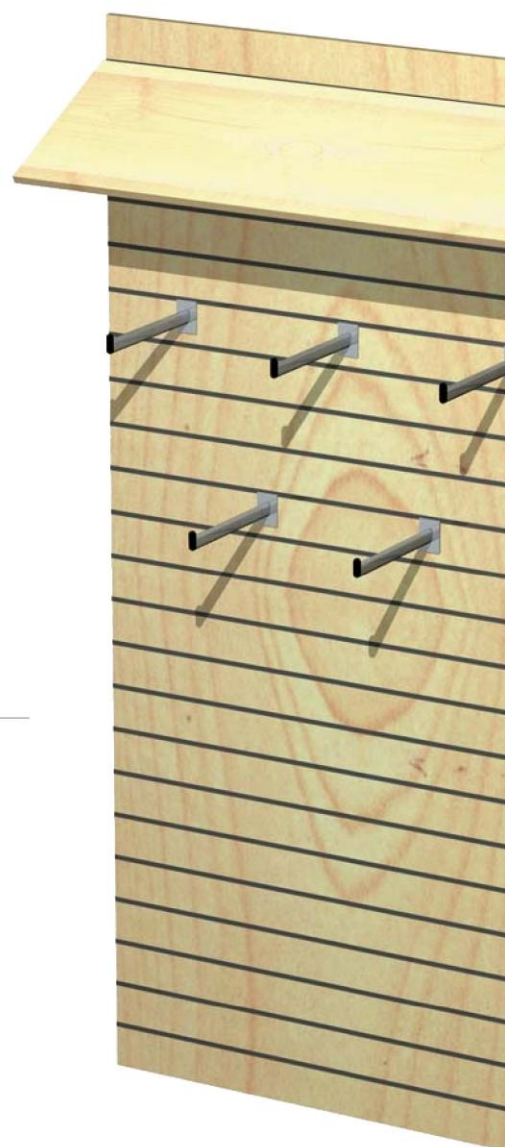

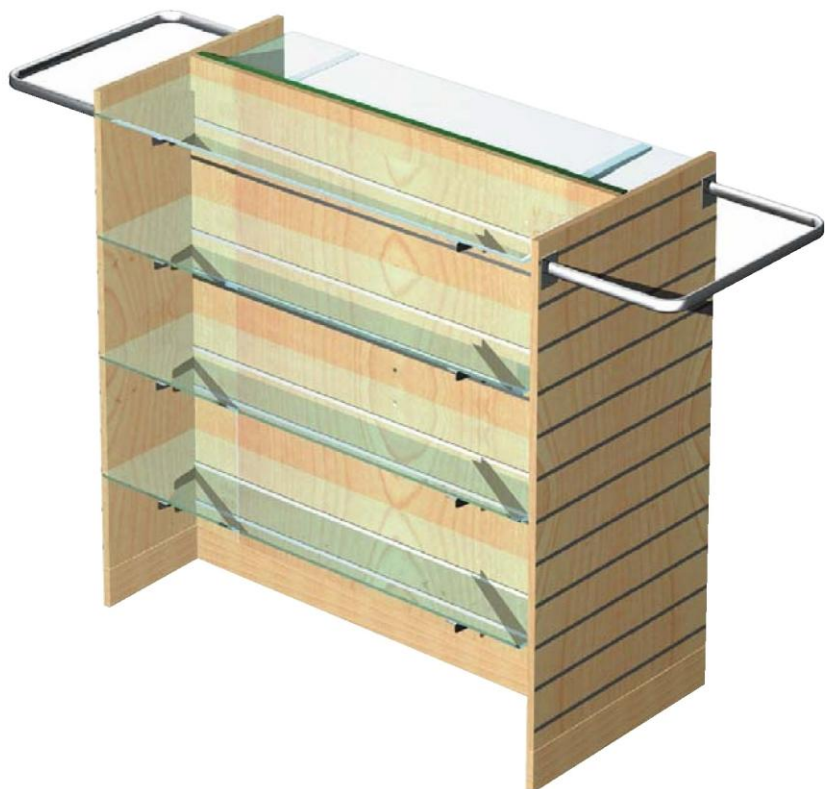
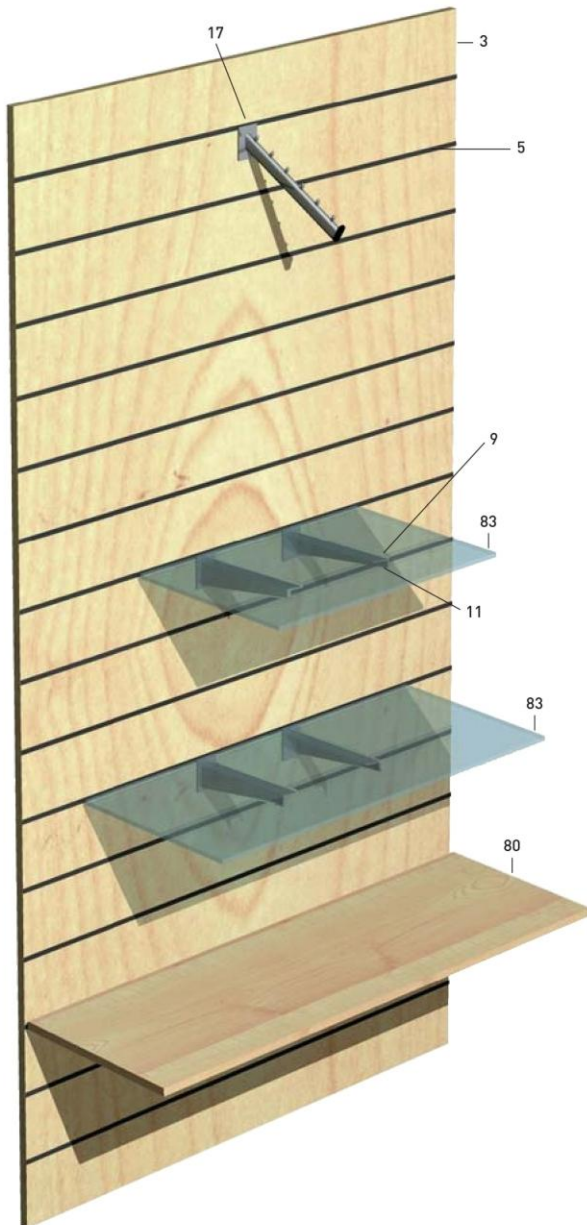

Type3 (1 pz.) L 1200 x 2400 x 19



Type5 (15 pz.) L 1200



Type9 (8 pz.)



Type11 (3 cp) L 350



Type17 (1 pz.) L 360



Type80 (1 pz.) L 1200 x 400 x 18



Type83 (1 pz.) L 600 x 400 x 8
(1 pz.) L 900 x 400 x 8



Type11 (3 cp) L 350

Type14 (2 pz.) L 1025
 (1 pz.) L 525



Type80 (3 pz.) L 600 x 400 x 18

Type92 (1 pz.)

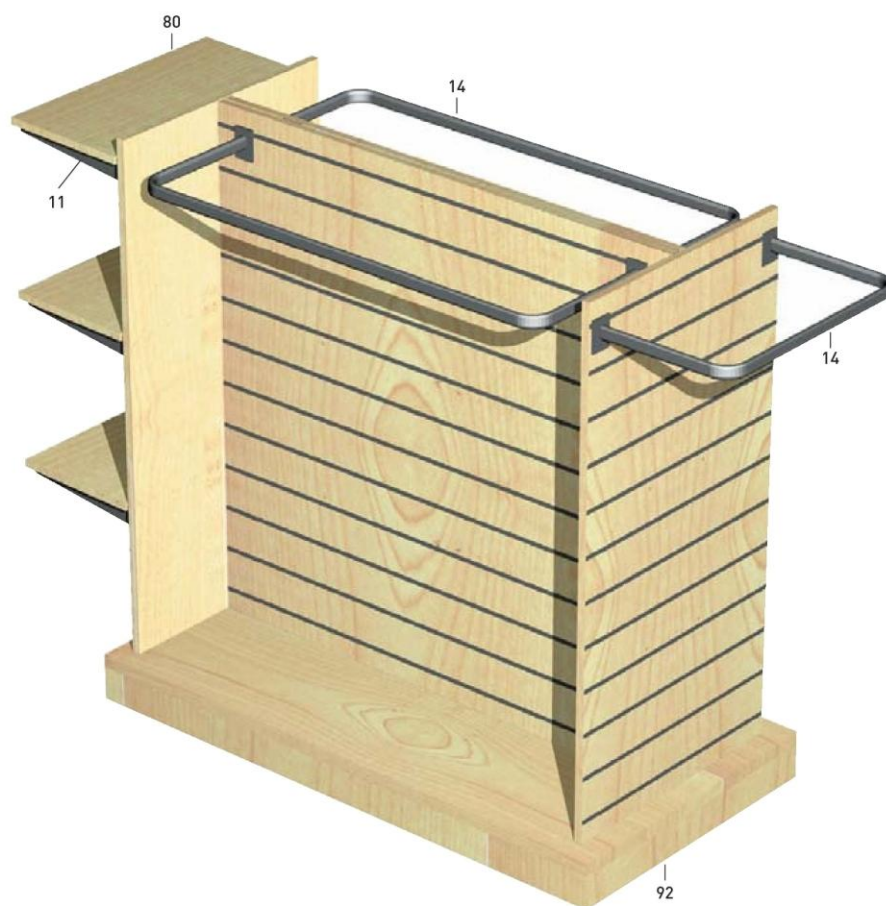

Finiture metallo
Metal finishes
Metallausführungen
Finitions métal
Отделка металла



Cod. 6A

Bianco 9006
White 9006
Weiß 9006
Blanc 9006
Белый 9006



Cod. 01

Cromato
Chrome plated
Chrom
Chromé
Хром

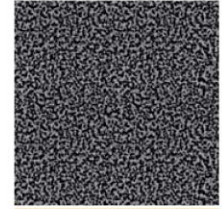

Cod. 19

Nero martellato
Hammered black
Schwarz Hammerschlag
Noir martelé
Мокрый асфальт

Finiture profili plastica
Plastic profiles finishes
Profils aus Plastik Ausführungen
Profils en plastique finitions
Отделка пластмассовых профилей



Cod. 06

Bianco
White
Weiß
Blanc
Белый



Cod. 05

Nero
Black
Schwarz
Noir
Черный

Finiture cristallo
Crystal finishes
Glasausführungen
Finitions cristal
Отделка стекла



Cod. 08

Trasparente
Clear
Transparent
Transparent
Прозрачный



Cod. 9G

Acidato
Etched
Satiniert
Acidé
Сатинированный

Ladeneinrichtungen und Zubehör Agencement de magasins et fournitures



Finiture legno
Wood finishes
Holzausführungen
Finitions bois
Отделка дерева



Cod. 0D

Acero
Maple
Ahorn
Erable
Клен



Cod. 0C

Faggio
Beech
Buche
Hêtre
Бук



Cod. 0L

Noce
Walnut
Walnuß
Noyer
Орех



Cod. 0J

Palissandro
Rosewood
Palisander
Palissandre
Палисандровое дерево



Cod. 0G

Rovere
Durmast
Heichenholz
Rouvre
Дуб



Cod. 2Q

Roble
Roble
Roble
Roble
Дуб



Cod. 2P

Wengé
Wengé
Wengé
Wengé
Венге'



Cod. 0K

Arancio
Orange
Orange
Orange
Оранжевый



Cod. 0B

Bianco
White
Weiß
Blanc
Белый



Cod. A7

Blu Baltico
Baltic blue
Kobaltblau
Bleu balte
Синий Балтик (сине-фиолетовый)



Cod. A1

Giallo pastello
Pastel yellow
Hellgelb
Jaune pastel
Желтый пастельный



Cod. 0F

Grigio
Grey
Grau
Gris
Серый



Cod. 0E

Magnolia
Magnolia
Magnolie
Magnolia
Магнолия

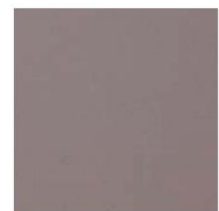

Cod. 0Z

Marrone
Brown
Braun
Marron
Коричневый



Cod. 0T

Metallizzato alluminio
Aluminium metallized
Aluminium-metallisiert
Métallisé aluminium
Алюминиевый металлик



Cod. A6

Rosso
Red
Rot
Rouge
Красный



Cod. 0U

Verde acqua
Pale green
Hellgrün
Vert d'eau
Лазурный



Cod. Rat

Laccato Lucido
Glossy Lacquered
Laqué Brillant
lackiert glänzend
Бестящий лакированный



Type 1

Pannello in MDF.
MDF panel.
MDF Paneel.
Panneau en MDF.
Панель MDF.

P: passo/pitch/Teilung/empattement/шар

Dim. (mm)	Cod.
L 1200 x 2400 x 19 P 100	SL0101--0000



Type 2

Pannello in MDF.
MDF panel.
MDF Paneel.
Panneau en MDF.
Панель MDF.

P: passo/pitch/Teilung/empattement/шар

Dim. (mm)	Cod.
L 2400 x 1200 x 19 P 100	SL0201--0000



Type 2 terminale

Pannello in MDF terminale.
MDF panel with half end slat.
MDF Paneel mit Halbbendlamelle.
Panneau en MDF avec demi rainure terminale.
Панель MDF Терминальная.

P: passo/pitch/Teilung/empattement/шар

Dim. (mm)	Cod.
L 2400 x 1200 x 19 P 100	SL0201--00T0



Type 3

Pannello in MDF.
MDF panel.
MDF Paneel.
Panneau en MDF.
Панель MDF.

P: passo/pitch/Teilung/empattement/шар

Dim. (mm)	Cod.
L 1200 x 2400 x 19 P 150	SL0301--0000



Type 4

Pannelo in MDF.
MDF panel.
MDF Paneel.
Panneau en MDF.
Панель MDF.

Dim. (mm)	Cod.
L 2400 x 1200 x 19 P 150	SL0401--0000

P: passo/pitch/Teilung/empattement/war



Type 4 terminale

Pannelo in MDF terminale.
MDF panel with half end slat.
MDF Paneel mit Halbendlamelle.
Panneau en MDF avec demi rainure terminale.
Панель MDF Терминальная.

Dim. (mm)	Cod.
L 2400 x 1200 x 19 P 150	SL0401--00T0

P: passo/pitch/Teilung/empattement/war



Type 5

Profilo a "T" in alluminio.
Aluminium "T" profile.
"T" Profil aus Aluminium.
Profil à "T" en aluminium.
"T"-образный алюминиевый профиль.

Dim. (mm)	Cod.
L 1200	SL0501--0000
L 2400	SL0502--0000



Type 6

Profilo a "T" in plastica.
Plastic "T" profile.
"T" Profil aus Plastik.
Profil à "T" en plastique.
"T"-образный пластмассовый профиль.

Dim. (mm)	Cod.
L 1200	SL0601--0000
L 2400	SL0602--0000



Type 7

Profilo a "L" in plastica.
Plastic "L" profile.
"L" Profil aus Plastik.
Profil à "L" en plastique.
"L"-образный пластмассовый профиль.

Dim. (mm)	Cod.
L 1200	SL0701--0000
L 2400	SL0702--0000



Type 8

Coppia mensole per ripiani.
Pair of shelf brackets.
Trägerpaar für Fächer.
Couple supports pour étagères.
Пара полкодержателей.

Dim. (mm)	Cod.
L 250	SL0801--0000
L 300	SL0802--0000



Type 9

Ventosa per ripiani in cristallo.
Sucker for crystal shelves.
Sauger für Glasfächer.
Ventouse pour étagère en cristal.
Присоска для стеклянной полки.

Dim. (mm)	Cod.
Ø 23	SL0901--0000



Type 10

Supporto per type 8.
Support for type 8.
Träger für Typ 8.
Support pour type 8.
Держатель вывески для типа 8.

Dim. (mm)	Cod.
	SL1001--0000



Type 11

Coppia mensole in lamiera per ripiano.
Pair of sheet shelf brackets.
Trägerpaar aus Blech für Fach.
Couple supports en tôle pour étagère.
Пара металлических полкодержателей.

Dim. (mm)	Cod.
L 200	SL1101--0000
L 250	SL1102--0000
L 300	SL1103--0000
L 350	SL1104--0000



Type 12

Coppia mensole inclinate in lamiera per ripiano.
Pair of slanted sheet shelf brackets.
Schräges Trägerpaar aus Blech für Fach.
Couple supports inclinés en tôle pour étagère.
Пара металлических наклонных полкодержателей.

Dim. (mm)	Cod.
L 300	SL1201--0000



Type 13

Separatore per ripiani.
Sheet splitter.
Trennung für Fächer.
Séparation pour étagères.
Разделитель для полки.

Dim. (mm)	Cod.
L 270	SL1301--0000



Type 14

Barra appenderia staccata.
Face-out hanging bar.
Hängestange.
Barre d'accrochage décalée.
Выступающее вешало.

Dim. (mm)	Cod.
L 525	SL1401--0000
L 1025	SL1402--0000



Type 15

Barra appenderia aderente.
Adherent hanging bar.
Gerade Hängestange.
Barre d'accrochage.
Прилегающее вешало.

Dim. (mm)	Cod.
L 525	SL1501--0000



Type 16

Barra diritta.
Straight arm.
Gerader Abhängearm.
Barre droite.
Прямой кронштейн.

Dim. (mm)	Cod.
L 300	SL1601--0000
L 400	SL1602--0000



Type 17

Barra inclinata.
Sloping arm.
Schräger Abhängearm.
Barre inclinée.
Наклонный кронштейн.

Dim. (mm)	Cod.
L 360	SL1701--0000
L 400	SL1702--0000



Type 18

Barra inclinata con ganci.
Hook sloping arm.
Schräger Abhängearm mit Haken.
Barre inclinée avec crochets.
Наклонный кронштейн с крючками.

Dim. (mm)	Cod.
L 360	SL1801--0000



Type 19

Barretta.
Hook.
Abhängearm.
Tige.
Кронштейн.

Dim. (mm)	Cod.
L 100	SL1901--0000
L 150	SL1902--0000
L 200	SL1903--0000
L 250	SL1904--0000



Type 20

Barretta.
Hook.
Abhängearm.
Tige.
Кронштейн.

Dim. (mm)	Cod.
L 300	SL2001--0000



Type 21

Barretta porta-blisters doppia.
Double hook blister-holder.
Doppelter Abhängearm für Blister-Packungen.
Tige porte-blisters double.
Двойной кронштейн для блистеров.

Dim. (mm)	Cod.
L 200	SL2101--0000
L 300	SL2102--0000



Type 22

Barretta a due gradini.
2-step hook.
2-Stufen Abhängearm.
Tige à deux marches.
2-х-ступенчатый крючок.

Dim. (mm)	Cod.
L 200	SL2201--0000



Type 23

Barretta a tre gradini.
3-step hook.
3-Stufen Abhängearm.
Tige à trois marches.
3-х-ступенчатый крючок.

Dim. (mm)	Cod.
L 300	SL2301--0000



Type 24

Espositore multiplio.
Clutch bag/purse display.
Vielfacher Aufsteller.
Elément expositif multiple.
Экспозитор.

Dim. (mm)	Cod.
L 400	SL2401--0000



Type 25

Espositore frontale.
Frontal display.
Frontaufsteller.
Tige frontale.
Фронтальный экспозитор.

Dim. (mm)	Cod.
L 260	SL2501--0000



Type 26

Gancio universale.
Universal hook.
Universalhaken.
Crochet universel.
Универсальный крючок.

Dim. (mm)	Cod.
L 43	SL2601--0000



Type 27

Espositore a cremagliera.
Zig zag stand.
Zahnrad aufsteller.
Elément expositif à crémaillère.
Зигзаговый экспозитор.

Dim. (mm)	Cod.
L 300	SL2701--0000



Type 28

Barra inclinata.
Sloping arm.
Schräger Abhängearm.
Tige inclinée.
Наклонный кронштейн.

Dim. (mm)	Cod.
L 360	SL2801--0000



Type 29

Porta pantaloni laterale.
Side trousers holder.
Seitiger Hosenträger.
Porte-pantalons latérale.
Боковой экспозитор для брюк.

Dim. (mm)	Cod.
L 360	SL2901--0000



Type 30

Porta pantaloni frontale.
Frontal trousers holder.
Fronthosenträger.
Porte-pantalons frontale.
Фронтальный экспозитор для брюк.

Dim. (mm)	Cod.
L 400	SL3001--0000



Type 31

Braccio appendieria girevole.
Rotating hanging arm.
Drehbarer Abhängearm.
Bras d'accrochage tournant.
Кронштейн-карусель.

Dim. (mm)	Cod.
L 300 x Ø 440	SL3101--0000



Type 32

Porta palloni.
Ball holder.
Ballträger.
Porte-ballons.
Подставка для мяча.

Dim. (mm)	Cod.
L 350 x Ø 150	SL3201--0000



Type 33

Espositore porta cinture.
Belt display.
Aufsteller für Gürtel.
Porte-ceintures.
Экспозитор для ремней.

Dim. (mm)	Cod.
L 300	SL3301--0000



Type 34

Appendino.
Display hanger.
Kleiderbügel.
Cintre.
Плечики.

Dim. (mm)	Cod.
L 430	SL3401--0000



Type 35

Porta scarpe.
Shoes display.
Aufsteller für Schuhe.
Porte-chaussures.
Полка для обуви.

Dim. (mm)	Cod.
L 290 x 290	SL3501--0000



Type 36

Espositore calzature singole.
Display for single shoe.
Aufsteller für Einzelschuh.
Élément pour une chaussure.
Одиночная подставка для обуви.

Dim. (mm)	Cod.
L 180	SL3601--0000



Type 37

Espositore porta camicie.
Shirt display.
Aufsteller für Hemden.
Étagère pour chemises.
Экспозитор для рубашек.

Dim. (mm)	Cod.
L 250 x 350	SL3701--0000



Type 38

Porta cappellini.
Millinery display.
Hütenträger.
Porte-chapeaux.
Экспозитор для головных уборов.

Dim. (mm)	Cod.
L 200 x 200	SL3801--0000



Type 39

Attacco per busto.
Fitting for bust.
Kupplung für Büste.
Attache pour buste.
Держатель торса.

Dim. (mm)	Cod.
L 175	SL3901--0000



Type 40

Supporto in lamiera per cassetiera/armadietto.
Sheet support for drawer cabinet/cabinet.
Träger aus Blech für Schublade/Schrank.
Support en tôle pour tiroirs/armoire.
Металлический держатель комода и шкафчика.

Dim. (mm)	Cod.
L 38 x 85	SL4001--0000



Type 41

Supporto in lamiera per pesi leggeri.
Flat accessory bracket.
Träger aus Blech für leichte Lasten.
Support en tôle pour poids légers.
Металлический держатель для легких изделий.

Dim. (mm)	Cod.
L 38 x 45	SL4101--0000



Type 42

Barra raggiata.
Sloping arm.
Schräger Abhängearm.
Tige inclinée.
Наклонный кронштейн.

Dim. (mm)	Cod.
L 305	SL4201--0000



Type 43

Profilo a "L" in alluminio.
Aluminium "L" profile.
"L" Profil aus Aluminium.
Profil à "L" en aluminium.
"L"-образный алюминиевый профиль.

Dim. (mm)	Cod.
L 1200	SL4301--0000



Type 44

Coppia supporti per ripiani in cristallo sp.8 mm.
Pair of brackets for glass shelves th. 8 mm.
Trägerpaar für Glasfächer D. 8 mm.
Couple supports pour étagères en cristal ép. 8 mm.
Пара держателей для стеклянных полок толщ. 8 мм.

Dim. (mm)	Cod.
L 40	SL4401--0000



Type 50

Pannello in MDF.
MDF panel.
MDF Paneel.
Panneau en MDF.
Панель MDF.

Dim. (mm)	Cod.
L 1200 x 1200 x 19 P 100	SL5001--0000

P: Passo/pitch/Teilung/empattement/war



Type 50 terminale

Pannello in MDF terminale.
MDF panel with half end slat.
MDF Paneel mit Halbendlamelle.
Panneau en MDF avec demi rainure terminale.
Панель MDF Терминальная.

Dim. (mm)	Cod.
L 1200 x 1200 x 19 P 100	SL5001--00T0

P: Passo/pitch/Teilung/empattement/war



Type 51

Pannello in MDF.
MDF panel.
MDF Paneel.
Panneau en MDF.
Панель MDF.

Dim. (mm)	Cod.
L 1200 x 1200 x 19 P 150	SL5101--0000

P: Passo/pitch/Teilung/empattement/war



Type 51 terminale

Pannello in MDF terminale.
MDF panel with half end slat.
MDF Paneel mit Halbendlamelle.
Panneau en MDF avec demi rainure terminale.
Панель MDF Терминальная.

P: Passo/pitch/Teilung/empattement/war

Dim. (mm)	Cod.
L 1200 x 1200 x 19 P 150	SL5101--00T0



Type 52

Barretta con puntale.
Hook with end cap.
Haken mit Endkappe.
Barre avec couvre-tête.
Крючок с заглушкой.

Dim. (mm)	Cod.
L 50	SL5201--0000
L 100	SL5202--0000
L 150	SL5203--0000
L 200	SL5204--0000
L 250	SL5205--0000
L 300	SL5206--0000



Type 53

Coppia mensole in lamiera per ripiano.
Sheet shelving twins.
Paar Fachträger aus Blech.
Couple supports en tôle pour étagère.
Пара металлических полкодержателей.

Dim. (mm)	Cod.
L 308	SL5301--0000



Type 54

Barretta laterale con porta-prezzo.
Side hook with price holder.
Seitenhaken mit Preishalter.
Barre latérale avec porte-prix.
Боковой держатель ценника.

Dim. (mm)	Cod.
L 235	SL5401--0000



Type 55

Barretta portablister doppia con porta-prezzo.
Double blister-hook with price holder.
Doppelte Blisterhaken mit Preishalter.
Barre double avec porte-prix.
Двойной кронштейн для блистеров с держателем ценника.

Dim. (mm)	Cod.
250/200	SL5501--0000
300/250	SL5502--0000
350/300	SL5503--0000
400/350	SL5504--0000
450/400	SL5505--0000



Type 56

Barretta portaocchiali.
Eye-glasses hook.
Brillenhaken.
Barre porte-lunettes.
Экспозитор для очков.

Dim. (mm)	Cod.
L 155 x 144	SL5601--0000



Type 57

Porta-depliant doppio.
Double brochure-holder.
Doppelter Broschürenhalter.
Porte-dépliant double.
Экспозитор рекламных проспектов.

Dim. (mm)	Cod.
L 190	SL5701--0000



Type 58

Barra diritta in tubo quadro.
Straight square arm.
Gerader Abhängearm mit Viereckrohr.
Barre droite en tube carré.
Прямой квадратный кронштейн.

Dim. (mm)	Cod.
L 305	SL5801--0000
L 400	SL5802--0000



Type 59

Barra inclinata in tubo quadro.
Slanted square arm.
Geschrägter Abhängearm mit Viereckrohr.
Barre inclinée en tube carré.
Наклонный квадратный кронштейн.

Dim. (mm)	Cod.
L 405	SL5901--0000



Type 60

Coppia mensole trasparenti per ripiano.
Clear bracket pair for shelf.
Transparentes Trägerpaar für Fach.
Couple supports transparents pour étagère.
Пара прозрачных полкодержателей.

Dim. (mm)	Cod.
L 200	SL6001--0000
L 300	SL6002--0000
L 350	SL6003--0000



Type 61

Ripiano semicircolare trasparente.
Clear semi-circle shelf.
Transparentes Halbkreisförmigfach.
Etagère à demi-cercle transparente.
Полукруглая прозрачная полка.

Dim. (mm)	Cod.
L 400 x 200	SL6101--0000



Type 62

Ripiano rettangolare trasparente.
Clear rectangular shelf.
Transparentes Rechteckfach.
Etagère rectangulaire transparente.
Прямоугольная прозрачная полка.

Dim. (mm)	Cod.
L 250 x 100	SL6201--0000



Type 63

Barretta trasparente.
Clear face-out blister.
Transparentes Abhängearm.
Tige transparente.
Прозрачный кронштейн.

Dim. (mm)	Cod.
L 100	SL6301--0000
L 150	SL6302--0000



Type 64

Gancio universale trasparente.
Clear multi-purpose hook.
Transparentes Universalhaken.
Crochet universel transparent.
Прозрачный универсальный крючок.

Dim. (mm)	Cod.
L 21	SL6401--0000



Type 65

Porta occhiali trasparente.
Clear spectacles support.
Transparentes Brillenträger.
Porte-lunettes transparent.
Прозрачная подставка для очков.

Dim. (mm)	Cod.
L 40	SL6501--0000

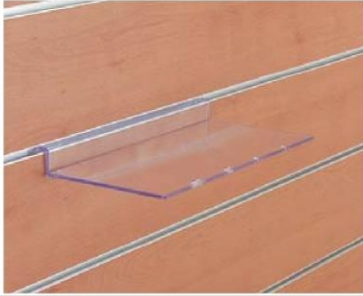

Type 66

Ripiano rettangolare trasparente.
Clear rectangular shelf.
Transparentes Rechteckfach.
Étagère rectangulaire transparente.
Прямоугольная прозрачная полка.

Dim. (mm)	Cod.
L 305 x 150	SL6601--0000



Type 67

Ripiano rettangolare trasparente.
Clear rectangular shelf.
Transparentes Rechteckfach.
Étagère rectangulaire transparente.
Прямоугольная прозрачная полка.

Dim. (mm)	Cod.
L 370 x 150	SL6701--0000



Type 68

Porta-prezzo trasparente per type 62-66-67-78.
Clear price-holder for type 62-66-67-78.
Transparentes Preisschildhalter für Typ 62-66-67-78.
Porte-prix transparent pour type 62-66-67-78.
Ценник прозрачный для типа 62-66-67-78.

Dim. (mm)	Cod.
L 120 x 35	SL6801--0000



Type 69

Porta telefonino trasparente.
Clear mobile-holder.
Transparentes Handysträger.
Porte-portables transparent.
Прозрачная подставка для телефона.

Dim. (mm)	Cod.
L 77 x 188	SL6901--0000



Type 70

Porta scarpe orientabile trasparente.
Clear adjustable shoe-holder.
Transparentes richtbarer Schuhträger.
Porte-chaussures orientable transparente.
Регулируемая подставка для обуви.

Dim. (mm)	Cod.
L 76 x 251	SL7001--0000



Type 71

Profil stondato terminale in alluminio.
Rounded end aluminium profile.
Abgerundetes Endprofil aus Aluminium.
Profil arrondi final en aluminium.
Закругленный терминальный алюминиевый профиль.

Dim. (mm)	Cod.
L 2400	SL7101--0000



Type 72

Profil stondato angolare in alluminio.
Rounded angular aluminium profile.
Abgerundetes Eckprofil aus Aluminium.
Profil arrondi angulaire en aluminium.
Закругленный угловой алюминиевый профиль.

Dim. (mm)	Cod.
L 2400	SL7201--0000



Type 73

Box porta calze trasparente.
Transparent tights-holder box.
Box Strumpfesträger transparent.
Boite porte-bas transparente.
Прозрачный экспозитор колгот.

Dim. (mm)	Cod.
L 190 x 375 x 204	SL7301--0000



Type 74

Box porta calze trasparente.
Transparent tights-holder box.
Box Strumpfesträger transparent.
Boite porte-bas transparente.
Прозрачный экспозитор колгот.

Dim. (mm)	Cod.
L 190 x 192 x 204	SL7401--0000

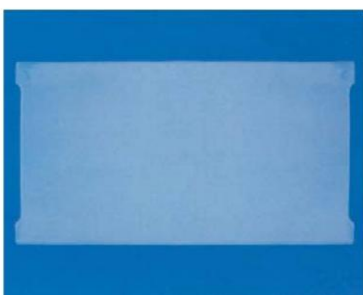

Type 75

Piastra antiscivolo trasparente per type 73-77.
Anti-slide transparent plate for type 73-77.
Rutschfeste Platte transparent für Typ 73-77.
Plaque anti-glissage transparente pour type 73-77.
Противоскользкая прозрачная пластинка для типа 73-77.

Dim. (mm)	Cod.
L 180 x 365 x 2	SL7501--0000

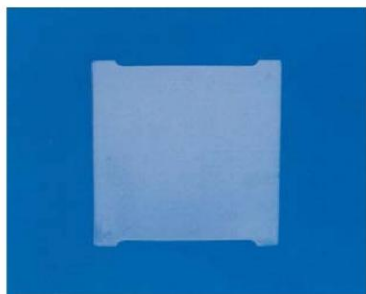

Type 76

Piastra antiscivolo trasparente per type 74.
Anti-slide transparent plate for type 74.
Rutschfeste Platte transparent für Typ 74.
Plaque anti-glissance transparente pour type 74.
Противоскользкая прозрачная пластинка для типа 74.

Dim. (mm)	Cod.
L 180 x 180 x 2	SL7601--0000



Type 77

Box porta calze trasparente.
Transparent tights-holder box.
Box Strumpfeträger transparent.
Boîte porte-bas transparente.
Прозрачный экспозитор колгот.

Dim. (mm)	Cod.
L 390 x 190 x 204	SL7701--0000

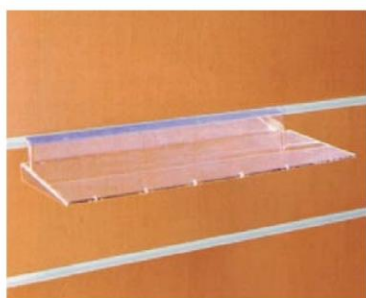

Type 78

Ripiano rettangolare trasparente.
Clear rectangular shelf.
Transparentes Rechteckfach.
Étagère rectangulaire transparente.
Прямоугольная прозрачная полка.

Dim. (mm)	Cod.
L 400 x 236	SL7801--0000



Type 79

Ripiano rettangolare inclinato trasparente.
Clear rectangular slanted shelf.
Transparentes Rechteckfach.
Étagère rectangulaire inclinée transparente.
Наклонная прямоугольная прозрачная полка.

Dim. (mm)	Cod.
L 175 x 293	SL7901--0000



Type 80

Ripiano in legno.
Wooden shelf.
Holzfach.
Étagère en bois.
Полка деревянная.

Dim. (mm)	Cod.
L 600 x 400 x 18	SL8001--0000
L 900 x 400 x 18	SL8002--0000
L 1200 x 400 x 18	SL8003--0000



Type 81

Ripiano in legno softformato.
Softforming wooden shelf.
Softforming Holzfach.
Etagère en bois softforming.
Полка деревянная с закругленным бортиком.

Dim. (mm)	Cod.
L 600 x 400 x 25	SL8101--0000
L 900 x 400 x 25	SL8102--0000
L 1200 x 400 x 25	SL8103--0000



Type 82

Ripiano in cristallo.
Crystal shelf.
Glasfach.
Etagère en cristal.
Полка стеклянная.

Dim. (mm)	Cod.
L 600 x 400 x 8	SL8201--0000
L 900 x 400 x 8	SL8202--0000
L 1200 x 400 x 8	SL8203--0000



Type 83

Ripiano in cristallo acidato.
Etched glass shelf.
Satinierter Glasfach.
Etagère en cristal acidé.
Полка стеклянная сатинованная.

Dim. (mm)	Cod.
L 600 x 400 x 8	SL8301--0000
L 900 x 400 x 8	SL8302--0000
L 1200 x 400 x 8	SL8303--0000



Type 90

Colonna girevole su pedana.
Rotating column on platform.
Drehbare Säule auf Podest.
Colonne tournante sur estrade.
Вращающаяся колонна на подставке.

P: Passo/pitch/Teilung/empattement/war
A: pannello/panel/paneel/panneau/панель
B: pedana/platform/podest/estrade/подставка

Dim. (mm)	Cod.
A: 400 x 1200 P 100	SL9001--0000
B: 700 x 700 x 100	



Type 91

Gondola a doppia "T".
Double "T"-shaped gondola.
Doppel "T"- förmige Gondola.
Gondole à double "T".
Гондола формы двойной "Т".

P: Passo/pitch/Teilung/empattement/war
A: pannello/panel/paneel/panneau/панель
C: base/base/tufl/pied/основа

Dim. (mm)	Cod.
A: 600 x 1200 1200 x 1200 P 100	SL9101--0000
C: 600 x 1200 x 100	



Type 92

Gondola a doppia "T" con pedana.
Double "T"-shaped gondola with platform.
Doppel "T"-förmige Gondola mit Podest.
Gondole à double "T" avec estrade.
Гондола формы двойной "Т" на подставке.

P: Passo/pitch/Teilung/empattement/war
A: pannello/panel/paneel/panneau/панель
B: pedana/platform/podest/estrade/подставка

	Dim. (mm)	Cod.
A:	600 x 1200 1200 x 1200 P 100	SL9201--0000
B:	700 x 1340 x 100	



Type 93

Gondola a croce.
Cross-shaped gondola.
Kreuzförmige Gondola.
Gondole à croix.
Гондола крестообразная.

P: Passo/pitch/Teilung/empattement/war
A: pannello/panel/paneel/panneau/панель
C: base/base/fuß/piéd/основа

	Dim. (mm)	Cod.
A:	600 x 1200 P 100	SL9301--0000
C:	600 x 600 x 100	



Type 94

Gondola a croce con pedana.
Cross-shaped gondola with platform.
Kreuzförmige Gondola mit Podest.
Gondole à croix avec estrade.
Гондола крестообразная на подставке.

P: Passo/pitch/Teilung/empattement/war
A: pannello/panel/paneel/panneau/панель
B: pedana/platform/podest/estrade/подставка

	Dim. (mm)	Cod.
A:	600 x 1200 P 100	SL9401--0000
B:	1000 x 1000 x 100	



Type 95

Colonna su pedana.
Column on platform.
Säule auf Podest.
Colonne sur base.
Колонна на подставке.

P: Passo/pitch/Teilung/empattement/war
A: pannello/panel/paneel/panneau/панель
B: pedana/platform/podest/estrade/подставка

	Dim. (mm)	Cod.
A:	280 x 1200 P 100	SL9501--0000
B:	450 x 450 x 240	



Article	Description	CHF
SLATBOARD	SLAT2000	
SL00000CJ434	PA.900X1200X19 P150 FAG.D19434	68.00
SL00000ND674	SLAT P100 NERO 600X2400 D13674	72.00
SL0101BX0000	SLAT P.100 B.CO LARICE TP 1	179.00
SL0101ZE0000	SLAT P.100 ZEBRANO TP 1	164.00
SL01010B0000	SLAT P.100 BIANCO TP 1	136.00
SL01010B0002	SLAT P.100 BIANCO SC.1 TP 1	171.00
SL01010C0000	SLAT P.100 FAGGIO TP 1	136.00
SL01010C0002	SLAT P.100 FAGGIO SC.1 TP 1	171.00
SL01010N0000	SLAT P.100 NERO TP 1	164.00
SL01010N0002	SLAT P.100 NERO SC.1 TP 1	186.00
SL01010T0000	SLAT P.100 MET. ALL. TP 1	163.00
SL01010T0002	SLAT P.100 MET.ALL.SC.1 TP 1	201.00
SL0101000000	SLAT P.100 GREZZO TP 1	127.00
SL01012P0000	SLAT P.100 WENGE' TP 1	179.00
SL01012P0002	SLAT P.100 WENGE' SC.1 TP 1	201.00
SL01012Q0000	SLAT P.100 ROBLE TP 1	179.00
SL01012Q0002	SLAT P.100 ROBLE SC.1 TP 1	201.00
SL0101610000	SLAT P.100 NERO OVERBLAC TP 1	613.00
SL01019T0000	SLAT P.100 BCO LUC. ACR. TP 1	325.00
SL01019U0000	SLAT P.100 BORD.LUC. ACR. TP 1	325.00
SL01019V0000	SLAT P.100 NERO LUC. ACR. TP 1	325.00
SL01019W0000	SLAT P.100 ARG.SPECC.ACR. TP 1	658.00
SL0201BX00T0	SLAT P100 BCO LARICE TERM.TP 2	179.00
SL02010B00T0	SLAT P.100 BIANCO TERM. TP 2	136.00
SL02010B00T2	SLAT P.100 BIANCO TER SC1 TP 2	171.00
SL02010B0000	SLAT P.100 BIANCO TP 2	136.00
SL02010B0002	SLAT P.100 BIANCO SC.1 TP 2	171.00
SL02010C00T0	SLAT P.100 FAGGIO TERM. TP 2	136.00
SL02010C00T2	SLAT P.100 FAGGIO TER SC1 TP 2	171.00
SL02010C0000	SLAT P.100 FAGGIO TP 2	136.00
SL02010C0002	SLAT P.100 FAGGIO SC.1 TP 2	171.00
SL02010N00T0	SLAT P.100 NERO TERM. TP 2	188.00
SL02010N0000	SLAT P.100 NERO TP 2	164.00
SL02010N0002	SLAT P.100 NERO SC.1 TP 2	188.00
SL02010T00T0	SLAT P.100 MET.ALL.TERM. TP 2	163.00
SL02010T0000	SLAT P.100 MET. ALL. TP 2	163.00
SL02010T0002	SLAT P.100 MET.ALL.SC.1 TP 2	201.00
SL02010000T0	SLAT P.100 GREZZO TERM. TP 2	127.00
SL0201000000	SLAT P.100 GREZZO TP 2	127.00
SL02012P00T0	SLAT P.100 WENGE' TERM. TP 2	179.00
SL02012Q00T0	SLAT P.100 ROBLE TERM. TP 2	179.00
SL0201610000	SLAT P.100 NER.OVER.TP2 D18673	613.00
SL02019T00T0	SL02 P100 BCO LUC. ACR. TERM.	325.00
SL02019T0000	SLAT P.100 BCO LUC. ACR. TP 2	325.00
SL02019U00T0	SL02 P100 BORD.LUC. ACR. TERM.	325.00
SL02019U0000	SLAT P.100 BORD.LUC. ACR. TP 2	325.00
SL02019V00T0	SL02 P100 NERO LUC. ACR. TERM.	325.00
SL02019V0000	SLAT P.100 NERO LUC. ACR. TP 2	325.00
SL02019W00T0	SL02 P100 ARG.SPECC.ACR. TERM.	658.00
SL02019W0000	SLAT P.100 ARG.SPECC.ACR. TP 2	658.00



SL0301BX0000	SLAT P.150 BIANCO LARICE TP 3	179.00
SL0301BX0002	SLAT P.150 BCO LARICE SC1 TP 3	201.00
SL0301WM0000	SLAT P.150 MOKA1 TP 3	164.00
SL03010B0000	SLAT P.150 BIANCO TP 3	136.00
SL03010B0002	SLAT P.150 BIANCO SC.1 TP 3	171.00
SL03010C0000	SLAT P.150 FAGGIO TP 3	136.00
SL03010C0002	SLAT P.150 FAGGIO SC.1 TP 3	171.00
SL03010N0000	SLAT P.150 NERO TP 3	164.00
SL03010N0002	SLAT P.150 NERO SC.1 TP 3	186.00
SL03010T0000	SLAT P.150 MET.ALL. TP 3	163.00
SL03010T0002	SLAT P.150 MET.ALL. SC.1 TP 3	201.00
SL0301000000	SLAT P.150 GREZZO TP 3	127.00
SL0301000002	SLAT P.150 GREZZO SC.1 TP 3	149.00
SL03012P0000	SLAT P.150 WENGE' TP 3	179.00
SL03012P0002	SLAT P.150 WENGE'SC.1 TP 3	201.00
SL03012Q0000	SLAT P.150 ROBLE TP 3	179.00
SL03012Q0002	SLAT P.150 ROBLE SC.1 TP 3	201.00
SL0301610000	SLAT P.150 NERO OVERBL. TP 3	613.00
SL03019T0000	SLAT P.150 BCO LUC. ACR. TP 3	325.00
SL03019U0000	SLAT P.150 BORD.LUC. ACR. TP 3	325.00
SL03019V0000	SLAT P.150 NERO LUC. ACR. TP 3	325.00
SL03019W0000	SLAT P.150 ARG.SPECC.ACR. TP 3	658.00
SL0401BX00T0	SLAT P.150 B.CO LARIC.TERM.TP4	179.00
SL0401BX0000	SLAT P.150 BIANCO LARICE TP 4	179.00
SL0401WM00T0	SLAT P.150 MOKA1 TERM.TP 4	164.00
SL0401ZE00T0	SLAT P.150 ZEBRANO TERM.TP 4	164.00
SL04010B00T0	SLAT P.150 BIANCO TERM. TP 4	136.00
SL04010B00T2	SLAT P.150 B.CO TERM.SC1 TP 4	171.00
SL04010B0000	SLAT P.150 BIANCO TP 4	136.00
SL04010B0002	SLAT P.150 BIANCO SC.1 TP 4	171.00
SL04010C00T0	SLAT P.150 FAGGIO TERM. TP 4	136.00
SL04010C00T2	SLAT P.150 FAGG.TERM.SC1 TP 4	171.00
SL04010C0000	SLAT P.150 FAGGIO TP 4	136.00
SL04010C0002	SLAT P.150 FAGGIO SC.1 TP 4	171.00
SL04010N00T0	SLAT P.150 NERO TERM. TP 4	164.00
SL04010N0000	SLAT P.150 NERO TP 4	149.00
SL04010N0002	SLAT P.150 NERO SC.1 TP 4	171.00
SL04010T00T0	SLAT P.150 MET.ALL. TERM.TP 4	163.00
SL04010T00T2	SLAT P.150 MET.AL.TER.SC1 TP 4	201.00
SL04010T0000	SLAT P.150 MET.ALL. TP 4	163.00
SL04010000T0	SLAT P.150 GREZZO TERM. TP 4	127.00
SL04010000T2	SLAT P.150 GREZ.TERM.SC1 TP 4	149.00
SL0401000000	SLAT P.150 GREZZO TP 4	127.00
SL0401000002	SLAT P.150 GREZZO SC.1 TP 4	149.00
SL04012P00T0	SLAT P.150 WENGE' TERM.TP 4	179.00
SL04012P0000	SLAT P.150 WENGE' TP 4	179.00
SL04012Q00T0	SLAT P.150 ROBLE TERM.TP 4	179.00
SL04012Q0000	SLAT P.150 ROBLE TP 4	179.00
SL04019T00T0	SL04 P.150 BCO LUC. ACR.TERM.	325.00
SL04019T0000	SLAT P.150 BCO LUC. ACR. TP 4	325.00
SL04019U00T0	SL04 P.150 BORD.LUC. ACR.TERM.	325.00
SL04019U0000	SLAT P.150 BORD.LUC. ACR. TP 4	325.00
SL04019V00T0	SL04 P.150 NERO LUC. ACR.TERM.	325.00
SL04019V0000	SLAT P.150 NERO LUC. ACR. TP 4	325.00
SL04019W00T0	SL04 P.150 ARG.SPECC.ACR.TERM.	658.00
SL04019W0000	SLAT P.150 ARG.SPECC.ACR. TP 4	658.00
SL0501000000	SLAT L.1200 TP 5	4.60
SL0502000000	SLAT L.2400 TP 5	9.20



SL0601050000	SLAT L.1200 NERO TP 6	2.90
SL0602050000	SLAT L.2400 NERO TP 6	7.00
SL0701050000	SLAT L.1200 NERO TP 7	3.50
SL0702050000	SLAT L.2400 NERO TP 7	7.00
SL0801010000	SLAT L.250 CROMATO TP 8	19.50
SL0802010000	SLAT L.300 CROMATO TP 8	19.50
SL0901080000	SLAT NEUTRO TP 9	0.20
SL1001080000	SLAT TRASPARENTE TP 10	2.70
SL1101010000	SLAT L.200 CROMATO TP 11	17.50
SL1101060000	SLAT L.200 BCO RAL 9010 TP 11	17.50
SL11012N0000	SLAT L.200 GRIGIO STRUCT.TP 11	17.50
SL1101260000	SLAT L.200 NERO OPACO TP 11	17.50
SL1102010000	SLAT L.250 CROMATO TP 11	19.50
SL1102260000	SLAT L.250 NERO OPACO TP 11	19.50
SL1103010000	SLAT L.300 CROMATO TP 11	22.00
SL1103060000	SLAT L.300 R.9010 TP 11	22.00
SL11032N0000	SLAT L.300 GRIGIO STRUCT.TP 11	22.00
SL1103260000	SLAT L.300 NERO OPC. TP 11	22.00
SL1103430000	SLAT L.300 VERDE ROULET.TP 11	22.00
SL11038G0000	SLAT L.300 SATINATO TP 11	36.00
SL11038L0000	SLAT L.300 VERN.CROM.OPC TP 11	24.00
SL1104010000	SLAT L.350 CROMATO TP 11	24.00
SL1104050000	SLAT L.350 NERO TP 11	24.00
SL1104260000	SLAT L.350 NERO OPACO TP 11	24.00
SL1201010000	SLAT L.300 CROMATO TP 12	22.00
SL1201260000	SLAT L.300 NERO OPACO TP 12	22.00
SL1201630000	SLAT L.300 BIANCO CREMA TP 12	22.00
SL1301010000	SLAT L.270 CROMATO TP 13	12.00
SL1401010000	SLAT L.525 CROMATO TP 14	29.50
SL1401260000	SLAT L.525 NERO OPACO TP 14	35.00
SL1402010000	SLAT L.1025 CROMATO TP 14	40.50
SL14022N0000	SLAT L.1025 GRI.STRUCT. TP 14	40.50
SL1402260000	SLAT L.1025 NERO OPACO TP 14	40.50
SL1501010000	SLAT L.525 CROMATO TP 15	24.50
SL1501050000	SLAT L.525 NERO TP 15	24.50
SL1502010000	SLAT L.1025 CROMATO TP 15	30.50
SL1601010000	SLAT L.300 CROMATO TP 16	7.90
SL16012N0000	SLAT L.300 GRIGIO STRUCT.TP 16	7.90
SL1601260000	SLAT L.300 NERO OPC..TP 16	7.90
SL1601430000	SLAT L.300 VERDE ROULET. TP 16	7.90
SL1602010000	SLAT L.400 CROMATO TP 16	8.70
SL1602260000	SLAT L.400 NERO OPACO TP 16	8.70
SL16028L0000	SLAT L.400 VERN.CROM.OPC.TP 16	9.60
SL1701010000	SLAT L.360 CROMATO TP 17	9.60
SL17012N0000	SLAT L.360 GRIGIO STRUCT.TP 17	9.60
SL1701260000	SLAT L.360 NERO OPACO TP 17	9.60
SL1701630000	SLAT L.360 B.CO CREMA TP 17	9.60
SL1702010000	SLAT L.400 CROMATO TP 17	11.50
SL1702260000	SLAT L.400 NERO OPACO TP 17	11.50
SL17028L0000	SLAT L.400 VERN.CROM.OPC.TP 17	12.50
SL1801010000	SLAT L.360 CROMATO TP 18	13.50
SL1901010000	SLAT L.100 CROMATO TP 19	2.80
SL1901060000	SLAT L.100 BIANCO TP 19	4.00
SL1901250000	SLAT L.100 VERNIC.ORO TP 19	4.40
SL1901260000	SLAT L.100 NERO OPACO TP 19	4.00
SL1901430000	SLAT L.100 VERDE ROULET. TP 19	4.00
SL1902010000	SLAT L.150 CROMATO TP 19	3.10
SL1902250000	SLAT L.150 VERNIC.ORO TP 19	4.40



SL1902260000	SLAT L.150 NERO OPACO TP 19	4.00
SL1903010000	SLAT L.200 CROMATO TP 19	3.40
SL1903260000	SLAT L.200 NERO OPACO TP 19	4.20
SL1903430000	SLAT L.200 VERDE ROULET. TP 19	4.20
SL1904010000	SLAT L.250 CROMATO TP 19	3.80
SL19042N0000	SLAT L.250 GRIGIO STRUCT.TP 19	4.20
SL1904260000	SLAT L.250 NERO OPACO TP 19	4.20
SL1904430000	SLAT L.250 VERDE ROULET. TP 19	4.20
SL1904520000	SLAT L.250 TRASP.OPC. TP 19	4.20
SL2001010000	SLAT L.300 CROMATO TP 20	4.00
SL2001260000	SLAT L.300 NERO OPACO TP 20	5.20
SL2001430000	SLAT L.300 VERDE ROULET. TP 20	5.20
SL2101010000	SLAT L.200 CROMATO TP 21	7.90
SL2102010000	SLAT L.300 CROMATO TP 21	8.50
SL2102260000	SLAT L.300 NERO OPACO TP 21	8.50
SL210906F621	ACC. X DOGATO RAL 9010 D 15621	14.00
SL2201010000	SLAT CROMATO TP 22	8.10
SL2301010000	SLAT L.300 CROMATO TP 23	9.50
SL2401010000	SLAT L.400 CROMATO TP 24	10.50
SL2501010000	SLAT CROMATO TP 25	16.00
SL2601010000	SLAT CROMATO TP 26	2.00
SL2701010000	SLAT L.300 CROMATO TP 27	8.30
SL2801010000	SLAT L.360 CROMATO TP 28	9.60
SL2801060000	SLAT L.360 BIANCO TP 28	9.60
SL2801430000	SLAT L.360 VERDE ROULET. TP 28	9.60
SL2809010000	SLAT L.410 CROMATO PROVA TP 28	9.60
SL2901010000	SLAT CROMATO TP 29	8.30
SL3001010000	SLAT L.360 CROMATO TP 30	8.30
SL3101010000	SLAT CROMATO TP 31	32.00
SL3201010000	SLAT L.150 CROMATO TP 32	9.60
SL3301010000	SLAT L.300 CROMATO TP 33	11.00
SL3401010000	SLAT L.430 CROMATO TP 34	9.60
SL3401260000	SLAT L.430 NERO OPACO TP 34	9.60
SL3501010000	SLAT CROMATO TP 35	29.50
SL3601010000	SLAT L.180 CROMATO TP 36	12.50
SL3701010000	SLAT CROMATO TP 37	21.50
SL3801010000	SLAT CROMATO TP 38	9.70
SL38012N0000	SLAT GRIGIO STRUCTURE TP 38	9.70
SL3801250000	SLAT VERNICIATO ORO TP 38	10.50
SL3801260000	SLAT NERO OPACO TP 38	9.70
SL38018K0000	SLAT RUGGINE TP 38	10.50
SL3901050000	SLAT NERO TP 39	28.50
SL39011B0000	SLAT GHISA ALLUMINIO TP 39	31.00
SL4001010000	SLAT CROMATO TP 40	4.80
SL4101010000	SLAT CROMATO TP 41	4.80
SL4201010000	SLAT L.300 CROMATO TP 42	12.00
SL4201060000	SLAT L.300 BCO 9010 TP 42	12.00
SL4201520000	SLAT L.300 TRASPAR.OPC. TP 42	12.00
SL4301000000	SLAT L.1200 TP 43	4.70
SL4302000000	SLAT L.2400 TP 43	9.50
SL4401000000	SLAT L.40 TP 44	8.80
SL5001WM00T0	SLAT P.100 MOKA1 TERM.TP 50	87.00
SL5001ZE00T0	SLAT P.100 ZEBRANO TERM. TP 50	87.00
SL50010B00T0	SLAT P.100 BIANCO TERM. TP 50	74.00
SL50010B00T1	SLAT P.100 B.CO TERM.SC2 TP 50	108.00
SL50010B00T2	SLAT P.100 B.CO TERM.SC1 TP 50	99.00
SL50010B0000	SLAT P.100 BIANCO TP 50	74.00



SL50010B0002	SLAT P.100 BIANCO SC1 TP 50	99.00
SL50010C00T0	SLAT P.100 FAGGIO TERM. TP 50	74.00
SL50010C00T2	SLAT P.100 FAGG.TERM.SC1 TP 50	99.00
SL50010C0000	SLAT P.100 FAGGIO TP 50	74.00
SL50010C0002	SLAT P.100 FAGGIO SC1 TP 50	99.00
SL50010N00T0	SLAT P.100 NERO TERM. TP 50	87.00
SL50010N00T2	SLAT P.100 NERO TERM.SC1 TP50	106.00
SL50010N0000	SLAT P.100 NERO TP 50	88.00
SL50010N0002	SLAT P.100 NERO SC1 TP 50	106.00
SL50010T00T0	SLAT P.100 MET.ALL. TERM.TP 50	89.00
SL50010T00T2	SLAT P.100 M.AL.TERM.SC1 TP 50	119.00
SL50010T0000	SLAT P.100 MET.ALLUMINIO TP 50	95.00
SL50010T0002	SLAT P.100 MET.ALL.SC.1 TP 50	119.00
SL50010000T0	SLAT P.100 GREZZO TERM. TP 50	70.00
SL50010000T2	SLAT P.100 GREZZ.TERM.SC1 TP50	80.00
SL5001000000	SLAT P.100 GREZZO TP 50	70.00
SL5001000002	SLAT P.100 GREZZO SC1 TP 50	90.00
SL50012P00T0	SLAT P.100 WENGE TERM.TP 50	95.00
SL50012P00T2	SLAT P.100 WENGE'TER.SC1 TP 50	119.00
SL50012P0000	SLAT P.100 WENGE' TP 50	95.00
SL50012Q00T0	SLAT P.100 ROBLE TERM.TP 50	95.00
SL50012Q0000	SLAT P.100 ROBLE TP 50	95.00
SL50016100T0	SLAT P.100 NR OVERBL.TERM.TP50	319.00
SL50019T00T0	SL50 P.100 BCO LUC.ACR. TERM.	205.00
SL50019T0000	SLAT P.100 BCO LUC.ACR. TP 50	205.00
SL50019U00T0	SL50 P.100 BORD.LUC.ACR.TERM.	205.00
SL50019U0000	SLAT P.100 BORD.LUC.ACR. TP 50	205.00
SL50019V00T0	SL50 P.100 NERO LUC.ACR.TERM.	205.00
SL50019V0000	SLAT P.100 NERO LUC.ACR. TP 50	205.00
SL50019W00T0	SL50 P.100 ARG.SPECC.ACR.TERM.	334.00
SL50019W0000	SLAT P.100 ARG.SPEC.ACR. TP 50	334.00
SL5101BX00T0	SLAT P.150 B.LARICE TERM.TP 51	95.00
SL5101WM00T0	SLAT P.150 MOKA1 TERM. TP 51	87.00
SL5101ZE00T0	SLAT P.150 ZEBRANO TERM. TP 51	87.00
SL51010B00T0	SLAT P.150 BIANCO TERM. TP 51	74.00
SL51010B00T2	SLAT P.150 B.CO TERM.SC1 TP 51	99.00
SL51010B0000	SLAT P.150 BIANCO TP 51	74.00
SL51010B0002	SLAT P.150 BIANCO SC1 TP 51	99.00
SL51010C00T0	SLAT P.150 FAGGIO TERM. TP 51	74.00
SL51010C00T2	SLAT P.150 FAGG.TERM.SC1 TP 51	99.00
SL51010C0000	SLAT P.150 FAGGIO TP 51	74.00
SL51010D0002	SLAT P.150 ACERO SC.1 TP 51	99.00
SL51010N00T0	SLAT P.150 NERO TERM. TP 51	74.00
SL51010N0000	SLAT P.150 NERO TP 51	87.00
SL51010N0002	SLAT P.150 NERO SC1 TP 51	106.00
SL51010T00T0	SLAT P.150 MET.ALL.TERM. TP 51	89.00
SL51010T0000	SLAT P.150 MET.ALLUM. TP 51	89.00
SL51010000T0	SLAT P.150 GREZZO TERM. TP 51	70.00
SL51010000T1	SLAT P.150 GREZ.TERM.SC1 TP 51	90.00
SL5101000000	SLAT P.150 GREZZO TP 51	70.00
SL51012P00T0	SLAT P.150 WENGE' TERM. TP 51	89.00
SL51012P00T2	SLAT P150 WENGÉ TERM.SC1 TP 51	119.00
SL51012P0000	SLAT P.150 WENGE' TP 51	95.00
SL51012Q00T0	SLAT P.150 ROBLE TERM. TP 51	89.00
SL51012Q00T2	SLAT P.150 ROBLE TERM.SC1 TP51	119.00
SL51012Q0000	SLAT P.150 ROBLE TP 51	95.00
SL51012Q0002	SLAT P.150 ROBLE SC.1 TP 51	119.00
SL51013C00T0	SLAT P150 LAC.9016 LU.TER.TP51	319.00



SL51016100T0	SLAT P.150 NR OVERB.TERM.TP 51	319.00
SL5101610000	SLAT P.150 NERO OVERBL. TP 51	319.00
SL51019T00T0	SLAT P.150 BCO LU.AC.TERM.TP51	205.00
SL51019T0000	SLAT P.150 BCO LUC. ACR. TP 51	205.00
SL51019U00T0	SLAT P.150 BDX LUC.AC.TER.TP51	205.00
SL51019U0000	SLAT P.150 BORD.LUC.ACR. TP 51	205.00
SL51019V00T0	SLAT P.150 NER.LU.AC.TERM.TP51	205.00
SL51019V0000	SLAT P.150 NERO LUC.ACR. TP 51	205.00
SL51019W00T0	SLAT P.150 ARG.SPE.AC.TER.TP51	334.00
SL51019W0000	SLAT P.150 ARG.SPECC.ACR.TP 51	334.00
SL51092PG709	SLAT P.300 WENGE' TP 51 D16709	95.00
SL51092QG709	SLAT P.300 ROBLE TP 51 D16709	95.00
SL5201010000	SLAT L.50 CROMATO TP 52	2.00
SL5202010000	SLAT L.100 CROMATO TP 52	2.00
SL5203010000	SLAT L.150 CROMATO TP 52	2.10
SL5203060000	SLAT L.150 BCO R9010 TP 52	2.10
SL52038L0000	SLAT L.150 VERN.CROM.OPC.TP 52	2.30
SL5204010000	SLAT L.200 CROMATO TP 52	2.10
SL5204260000	SLAT L.200 NERO OPACO TP 52	2.10
SL5205010000	SLAT L.250 CROMATO TP 52	2.20
SL5206010000	SLAT L.300 CROMATO TP 52	2.20
SL5206260000	SLAT L.300 NERO OPACO TP 52	2.20
SL52068L0000	SLAT L.300 VERN.CROM.OPC.TP 52	2.40
SL5301010000	SLAT L.300 CROMATO TP 53	13.00
SL5301260000	SLAT L.300 NERO OPACO TP 53	13.00
SL5401010000	SLAT L.235 CROMATO TP 54	4.20
SL5501010000	SLAT L.200 CROMATO TP 55	4.80
SL5502010000	SLAT L.250 CROMATO TP 55	5.50
SL5503010000	SLAT L.300 CROMATO TP 55	6.20
SL5504010000	SLAT L.350 CROMATO TP 55	6.60
SL5505010000	SLAT L.400 CROMATO TP 55	7.40
SL5601010000	SLAT CROMATO TP 56	6.20
SL5701010000	SLAT CROMATO TP 57	12.50
SL5801010000	SLAT L.300 CROMATO TP 58	8.10
SL5802010000	SLAT L.400 CROMATO TP 58	10.00
SL5901010000	SLAT L.400 CROMATO TP 59	11.00
SL6001080000	SLAT L.200 TRASPARENTE TP 60	7.90
SL6002080000	SLAT L.300 TRASPARENTE TP 60	8.80
SL6003080000	SLAT L.350 TRASPARENTE TP 60	10.50
SL6101080000	SLAT L.400 TRASPARENTE TP 61	6.50
SL6201080002	SLAT L.250 TRASPARENTE TP 62	2.70
SL6301080000	SLAT L.100 TRASPARENTE TP 63	1.20
SL6302080000	SLAT L.150 TRASPARENTE TP 63	1.20
SL6401080000	SLAT TRASPARENTE TP 64	0.90
SL6501080000	SLAT TRASPARENTE TP 65	2.40
SL6601080002	SLAT TRASPARENTE TP 66	5.70
SL6701080002	SLAT TRASPARENTE TP 67	5.70
SL6801080000	SLAT TRASPARENTE TP 68	0.80
SL6901080000	SLAT TRASPARENTE TP 69	5.70
SL7001080000	SLAT TRASPARENTE TP 70	5.70
SL7101000000	SLAT L.2400 TP 71	44.00
SL7201000000	SLAT L.2400 TP 72	56.00
SL7301080000	SLAT TRASPARENTE TP 73	23.50
SL7401080002	SLAT TRASPARENTE TP 74	19.50
SL7601080000	SLAT ANTI-SCIVOLO TP 76	4.00
SL7701080002	SLAT TRASPARENTE TP 77	26.50
SL7801080000	SLAT TRASPARENTE TP 78	11.00
SL7901080000	SLAT TRASPARENTE TP 79	5.10



SL8001BX0000	SLAT 600X400 B.CO LARICE TP80	32.00
SL80010B0000	SLATBOARD 600X400 BIANCO TP 80	26.50
SL80010C0000	SLATBOARD 600X400 FAGGIO TP 80	26.50
SL80010N0000	SLATBOARD 600X400 NERO TP 80	26.50
SL80010T0000	SLATBOARD 600X400 MET.AL TP 80	32.00
SL80012P0000	SLATBOARD 600X400 WENGE' TP 80	32.00
SL80012Q0000	SLATBOARD 600X400 ROBLE TP 80	32.00
SL80019T0000	SLAT 600X400 BCO LUC. ACR.TP80	44.00
SL80019U0000	SLAT 600X400 BORD.LUC.ACR.TP80	44.00
SL80019V0000	SLAT 600X400 NERO LUC.ACR.TP80	44.00
SL80019W0000	SLAT 600X400 ARG.SPEC.ACR.TP80	74.00
SL8002BX0000	SLATBOARD 900X400 BCO LAR.TP80	38.50
SL80020B0000	SLATBOARD 900X400 BIANCO TP 80	32.00
SL80020C0000	SLATBOARD 900X400 FAGGIO TP 80	32.00
SL80020N0000	SLATBOARD 900X400 NERO TP 80	32.00
SL80020T0000	SLATBOARD 900X400 MET.AL TP 80	38.50
SL80029T0000	SLAT 900X400 BCO LUC.ACR.TP80	55.00
SL80029U0000	SLAT 900X400 BORD.LUC.ACR.TP80	55.00
SL80029V0000	SLAT 900X400 NERO LUC.ACR.TP80	55.00
SL80029W0000	SLAT 900X400 ARG.SPEC.ACR.TP80	96.00
SL8003BX0000	SLAT 1200X400 BCO LARICE TP80	48.00
SL80030B0000	SLATBOARD 1200X400 BIANCO TP80	40.00
SL80030C0000	SLATBOARD 1200X400 FAGGIO TP80	40.00
SL80030N0000	SLATBOARD 1200X400 NERO TP80	40.00
SL80030T0000	SLATBOARD 1200X400 MET.AL TP80	48.00
SL80032P0000	SLATBOARD 1200X400 WENGE' TP80	48.00
SL80032Q0000	SLATBOARD 1200X400 ROBLE TP80	48.00
SL80039T0000	SLAT 1200X400 BCO LUC.ACR.TP80	68.00
SL80039U0000	SLAT 1200X400 BORD.LU.ACR.TP80	68.00
SL80039V0000	SLAT 1200X400 NER.LUC.ACR.TP80	68.00
SL80039W0000	SLAT 1200X400 ARG.SPE.ACR.TP80	131.00
SL81010B0000	SLAT 600X400 SOF.BIANCO TP 81	28.50
SL81010C0000	SLAT 600X400 SOF.FAGGIO TP 81	28.50
SL81010T0000	SLAT 600X400 SOF.MET.AL TP 81	34.00
SL81012Q0000	SLAT 600X400 SOF. ROBLE TP 81	40.50
SL8102BX0000	SLAT 900X400 SOF.BCO LAR.TP 81	60.00
SL81020B0000	SLAT 900X400 SOF.BIANCO TP 81	34.50
SL81020C0000	SLAT 900X400 SOF.FAGGIO TP 81	34.50
SL81020T0000	SLAT 900X400 SOF.MET.ALL.TP 81	41.50
SL81020W0000	SLAT 900X400 SOF. BLU BH.TP 81	51.00
SL81022P0000	SLAT 900X400 SOF.WENGE' TP 81	56.00
SL81030B0000	SLAT 1200X400 SOF.BIANCO TP 81	42.00
SL81030C0000	SLAT 1200X400 SOF.FAGGIO TP 81	42.00
SL81030T0000	SLAT 1200X400 SOF.MET.AL TP 81	46.00
SL81030W0000	SLAT 1200X400 SOF.BLU BH.TP 81	64.00
SL8201080000	SLAT 600X400 TRASP. TP 82	48.00
SL8202080000	SLAT 900X400 TRASP. TP 82	66.00
SL8203080000	SLAT 1200X400 TRASP. TP 82	83.00
SL83019G0000	SLAT 600X400X8 ACIDATO TP 83	83.00
SL83029G0000	SLAT 900X400X8 ACIDATO TP 83	105.00
SL83039G0000	SLAT 1200X400X8 ACIDATO TP 83	136.00
SL8401080000	SLAT 55X39 TRASPARENTE TP 84	1.50
SL9001BX0000	SLAT P.100 BCO LARICE TP 90	631.00
SL90010B0000	SLAT P.100 BIANCO TP 90	526.00
SL90010C0000	SLAT P.100 FAGGIO TP 90	526.00
SL90010N0000	SLAT P.100 NERO TP 90	578.00
SL90010T0000	SLAT P.100 MET.ALL. TP 90	631.00
SL90012P0000	SLAT P.100 WENGE' TP 90	631.00



SL91010B0000	SLAT P.100 BIANCO	TP 91	1'007.00
SL91010C0000	SLAT P.100 FAGGIO	TP 91	1'007.00
SL91010N0000	SLAT P.100 NERO	TP 91	1'108.00
SL91010T0000	SLAT P.100 MET.ALL.	TP 91	1'209.00
SL91012Q0000	SLAT P.100 ROBLE	TP 91	1'209.00
SL9201BX0000	SLAT P.100 BIANCO LARICE	TP 92	1'472.00
SL9201WM0000	SLAT P.100 MOKA1	TP 92	1'349.00
SL92010B0000	SLAT P.100 BIANCO	TP 92	1'226.00
SL92010C0000	SLAT P.100 FAGGIO	TP 92	1'226.00
SL92010N0000	SLAT P.100 NERO	TP 92	1'349.00
SL92010T0000	SLAT P.100 MET.ALL.	TP 92	1'472.00
SL92012P0000	SLAT P.100 WENGE'	TP 92	1'472.00
SL92012Q0000	SLAT P.100 ROBLE	TP 92	1'472.00
SL93010B0000	SLAT P.100 BIANCO	TP 93	657.00
SL93010C0000	SLAT P.100 FAGGIO	TP 93	657.00
SL93010N0000	SLAT P.100 NERO	TP 93	723.00
SL93010T0000	SLAT P.100 MET.ALL.	TP 93	788.00
SL94010B0000	SLAT P.100 BIANCO	TP 94	854.00
SL94010C0000	SLAT P.100 FAGGIO	TP 94	854.00
SL94010N0000	SLAT P.100 NERO	TP 94	949.00
SL94010T0000	SLAT P.100 MET. ALL.	TP 94	1'025.00
SL94012P0000	SLAT P.100 WENGE'	TP 94	1'025.00
SL95010B0000	SLAT P.100 BIANCO	TP 95	438.00
SL95010C0000	SLAT P.100 FAGGIO	TP 95	438.00
SL95010N0000	SLAT P.100 NERO	TP 95	482.00
SL95010T0000	SLAT P.100 MET.ALL.	TP 95	526.00

Preise ab unseren Lokalitäten. Preisänderung vorbehalten.
Diese Preisliste annulliert die vorhergehende.
Lieferfrist ca. 4 Wochen ab Auftragsbestätigung. **Exkl. MwSt**
Fotos, Farben und Grössen können vom Original abweichen.

Prix départ de nos locaux. Sous réserve de modifications. **TVA non incluse**
La présente liste annule et remplace toute précédente liste.
Délai de livraison hors stock, env. 4 sem. dès confirmation commande.
Photos, couleurs et mesures non contractuelles.