

Ladeneinrichtungen und Zubehör
Agencement de magasins et fournitures



collection2015

Stender Collection FID



**New
Prices**



accessori per stender

Accessori per stender

Accessories for garment rail
Zubehör für Rollständer
Accessoires pour penderie
Accesorios para perchero

CODICE	A
406/I	30

Broche inclinata per barra tubo ovale

Sloping arm for oval tube
Schrägarml für Ovalrohrstange
Bras incliné pour barre tube ovale
Brazo inclinado para barra oval



CODICE	A
406/D	35

Broche dritta per barra tubo ovale

Straight arm for oval tube
Gerader Arm für Ovalrohrstange
Bras droit pour barre tube ovale
Brazo recto para barra oval



NEW

collection

stender

Stender fisso

Fix garment rail
Rollständer, starr
Penderie fixe
Perchero fijo



Ø 5

Ruota nera Ø 5 cm - attacco rapido
Black castor Ø 5 cm - quick connection
Schwarze Rolle Ø 5 cm - Schnellverbindung
Roulette noir Ø 5 cm - attaque rapide
Rueda negra Ø 5 cm - engancho rapido



Ø 8

Ruota nera Ø 8 cm - attacco rapido
Black castor Ø 8 cm - quick connection
Schwarze Rolle Ø 8 cm - Schnellverbindung
Roulette noir Ø 8 cm - attaque rapide
Rueda negra Ø 8 cm - engancho rapido



Ø 10

Ruota nera Ø 10 cm - attacco filetto
Black castor Ø 10 cm - connection
Schwarze Rolle Ø 10 cm - Schraubgewinde
Roulette noir Ø 10 cm - attaque
Rueda negra Ø 10 cm - filete



Stender fisso

Fix garment rail / Rollständer, starr
Penderie fixe / Perchero fijo

CODICE	A	B	⇕	┌─┐
209/E	143	5	—	■
209/E/80	143	8	—	■
209/E/100	143	10	—	■ NEW
209/E/A	100	5	—	—
209/E/A/80	100	8	—	—

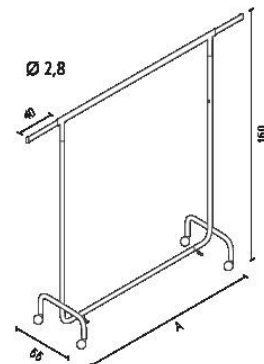

Barra intermedia ─┬─ (con prolunghe)

Cross bar (with side extension arms)
Zwischenstange (mit Armen)
Barre intermédiaire (avec bras)
Barra intermedia (con brazos)

CODICE	A	B
209500/E	143	60

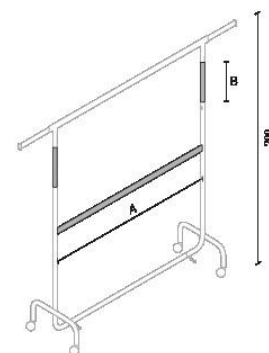

11

Stender fisso

Fix garment rail / Rollständer, starr
Penderie fixe / Perchero fijo

CODICE	A	B	C	D	E
ST20982	143	8	—	■	NEW

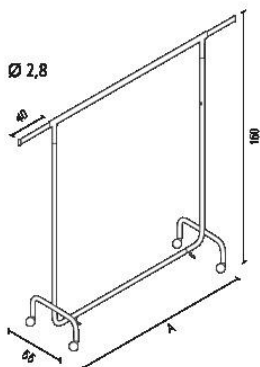

Stender fisso grigio antracite gofrato

Fix garment rail charcoal grey embossed
Rollständer grau anthrazit gaufriert
Penderie fixe gris anthracite gaufré
Perchero fijo gris antracita gofrado



Ø 8

Ruota nera Ø 8 cm - attacco rapido
Black castor Ø 8 cm - quick connection
Schwarze Rolle Ø 8 cm - Schnellverbindung
Roulette noir Ø 8 cm - attaque rapide
Rueda negra Ø 8 cm - enganche rapido

NEW

collection

stender

Stender #NESSUNA fatica grigio antracite goffrato

Fix garment rail charcoal grey embossed
Rollständer grau anthrazit gaufriert
Penderie fixe gris anthracite gaufré
Perchero fijo gris antracita gofrado



Stender fisso

Fix garment rail / Rollständer, starr
Penderie fixe / Perchero fijo

CODICE	A	b	↕	I	
ST3020912	143	10	—	—	NEW

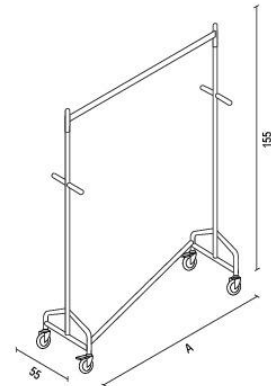

Barra Intermedia con prolunghe

Cross bar with side extension arms
Zwischenstange mit Armen
Barre intermédiaire avec bras
Barra intermedia con brazos

CODICE	
ST3020922	NEW

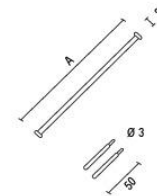

Ø 10

Ruota nera Ø 10 cm - attacco filetto
Black castor Ø 10 cm - connection
Schwarze Rolle Ø 10 cm - Schraubgewinde
Roulette noir Ø 10 cm - attaque
Rueda negra Ø 10 cm - filete



stender

Stender regolabile "mini"

Adjustable "mini" garment rail
 "Mini" Rollständer, höhenverstellbar
 Penderie "mini" réglable
 "Mini" perchero regulable

CODICE	A	b	↕	I
161150	83	5	RM1	—

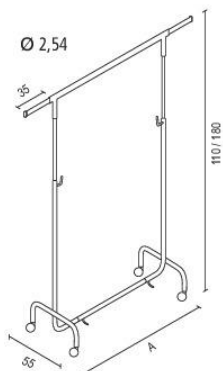

Stender regolabile

Adjustable garment rail
 Rollständer, höhenverstellbar
 Penderie réglable
 Perchero regulable



Ø 5
 Ruota nera Ø 5 cm - attacco rapido
 Black castor Ø 5 cm - quick connection
 Schwarze Rolle Ø 5 cm - Schnellverbindung
 Roulette noir Ø 5 cm - attaque rapide
 Rueda negra Ø 5 cm - enganche rapido



RM1
 con maniglia
 by metallic screw
 durch Schraube
 par petite poignée
 con asas

Stender regolabile

Adjustable garment rail
Rollständer, höhenverstellbar
Penderie réglable
Perchero regulable



RM1
con maniglia
by metallic screw
durch Schraube
par petite poignée
con asas



RN1
con giunto a scatto
by pull out system
durch Schnäpper
par loquet
mediante regulador

Ø 5

Ruota nera Ø 5 cm - attacco rapido
Black castor Ø 5 cm - quick connection
Schwarze Rolle Ø 5 cm - Schnellverbindung
Roulette noir Ø 5 cm - attaque rapide
Rueda negra Ø 5 cm - enganche rapido



Ø 8

Ruota nera Ø 8 cm - attacco rapido
Black castor Ø 8 cm - quick connection
Schwarze Rolle Ø 8 cm - Schnellverbindung
Roulette noir Ø 8 cm - attaque rapide
Rueda negra Ø 8 cm - enganche rapido



Stender regolabile

Adjustable garment rail
Rollständer, höhenverstellbar
Penderie réglable / Perchero regulable

CODICE	A	h	↕	┌
209/R	143	5	RM1	■
209/R/80	143	8	RM1	■
209/R/1	100	5	RM1	■
209/R/1/80	100	8	RM1	■
ST209R	143	5	RN1	■
ST209R80	143	8	RN1	■
ST209RI	100	5	RN1	■
ST209RI80	100	8	RN1	■

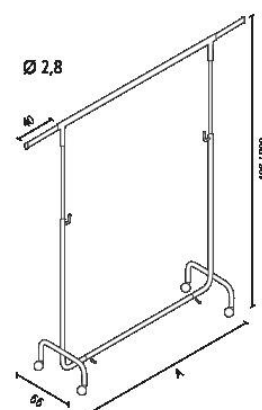

Barra intermedia ┌

Cross bar / Zwischenstange
Barre intermédiaire / Barra intermedia

CODICE	A
209800	143
209900	100

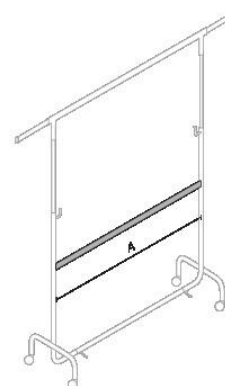

Stender

Garment rail / Rollständer / Penderie / Perchero

CODICE	A	Ø	↕	I	
ST00080	143	8	—	—	NEW
ST00180	143	8	RM1	—	NEW
ST01080	100	8	RM1	—	NEW

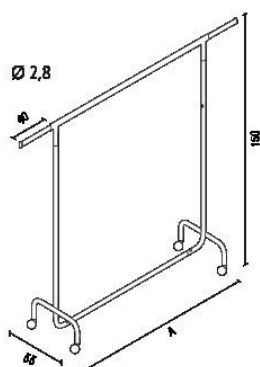

Stender

Garment rail
Rollständer
Penderie
Perchero



Ø 8
Ruota nera Ø 8 cm - attacco rapido
Black castor Ø 8 cm - quick connection
Schwarze Rolle Ø 8 cm - Schnellverbindung
Roulette noir Ø 8 cm - attaque rapide
Rueda negra Ø 8 cm - enganche rapido

RM1
con maniglia / by metallic screw
durch Schraube / par petite poignée
con asas



Stender regolabile

Adjustable garment rail
 Rollständer, höhenverstellbar
 Penderie réglable
 Perchero regulable



RS1

con giunto a scatto
 by pull out system
 durch Schnäpper
 par loquet
 mediante regulador



Ø 8

Ruota nera Ø 8 cm - attacco filetto
 Black castor Ø 8 cm - connection
 Schwarze Rolle Ø 8 cm - Schraubgewinde
 Roulette noir Ø 8 cm - attaque
 Rueda negra Ø 8 cm - filete



Stender regolabile modello lusso

Garment rail top version, adjustable
 Rollständer Top Version, höhenverstellbar
 Penderie réglable modèle luxe
 Perchero regulable version lujo

CODICE	A	Ø	↕	⊥
211	140	8	RS1	—

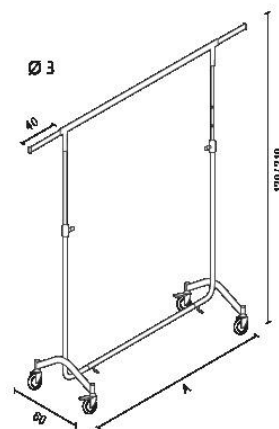

Stender porta-costumi, ruote Ø 8 cm

Swimwear stand, castors Ø 8 cm

Badeanzugständer, Rollen Ø 8 cm

Penderie pour maillots de bain, roulettes Ø 8 cm

Perchero para bañadores, ruedas Ø 8

CODICE	A	h	↕	
ST14550	145	8	—	NEW

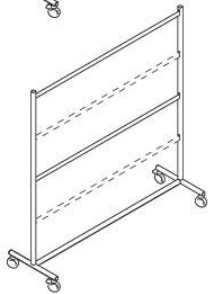
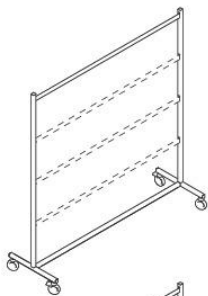
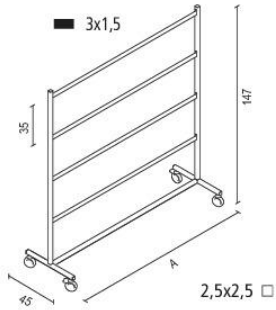

Stender regolabile

Adjustable garment rail

Rollständer, höhenverstellbar

Penderie réglable

Perchero regulable



Ø 8

Ruota nera Ø 8 cm - attacco filetto

Black castor Ø 8 cm - connection

Schwarze Rolle Ø 8 cm - Schraubgewinde

Roulette noir Ø 8 cm - attaque

Rueda negra Ø 8 cm - filete

NEW

collection

stender

Stender regolabile

Adjustable garment rail
Rollständer, höhenverstellbar
Penderie réglable
Perchero regulable



Stender porta-appendini 4 barre appenderia

Hanging rail 4 bars
Kleiderbügelständer mit 4 Querstangen
Penderie pour cintres 4 barres
Perchero perchas 4 barras

CODICE	A	h	∅	NEW
ST80120	84	5	—	NEW
ST80120/S	84	5	—	NEW

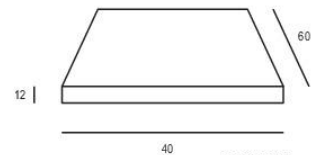
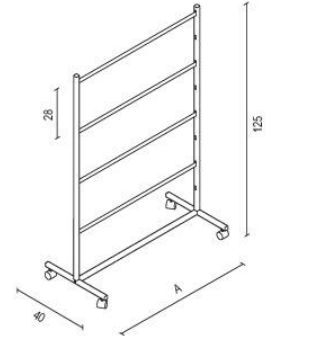

ST80120/S
in scatola
in carton
im Karton
dans carton
en caja

Set di 4 barre appenderia per stender

Set of 4 bars for Hanging rail
Set mit 4 Querstangen für Kleiderbügelständer
Set de 4 barres pour penderie cintres
Set de 4 barras para perchero perchas

CODICE	A	h	∅	NEW
ST8012010	80	—	—	NEW

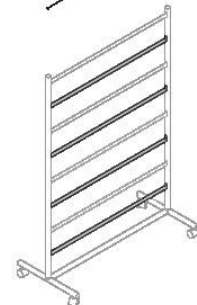
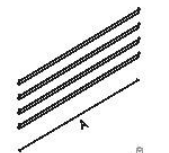

∅ 5

Ruota nera ∅ 5 cm - attacco filetto
Black castor ∅ 5 - connection
Schwarze Rolle ∅ 5 - Schraubgewinde
Roulette noir ∅ 5 - attaque
Rueda negra ∅ 5 - filete



stender

Espositore portascarpe con traverso intermedio

Shoe Stand with cross bar, chrome finish
Schuhverkaufsänder mit Zwischenquerstange
(mit Zwischenstab), verchromt
Présentoir chaussures avec entretoise intermédiaire,
chromé
Perchero para zapatos con barra intermedia, cromado

CODICE	A	h	↕
ST28400	80	5	—

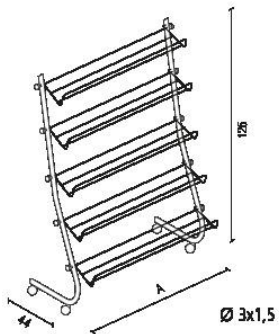

Stender regolabile

Adjustable garment rail
Rollständer, höhenverstellbar
Penderie réglable
Perchero regulable



Ø 5
Ruota nera Ø 5 cm - attacco filetto
Black castor Ø 5 - connection
Schwarze Rolle Ø 5 - Schraubgewinde
Roulette noir Ø 5 - attache
Rueda negra Ø 5 - filete

NEW

collection

stender

Stender regolabile

Adjustable garment rail
Rollständer, höhenverstellbar
Penderie réglable
Perchero regulable



RN1

con giunto a scatto / by pull out system
durch Schnäpper / par loquet
mediante regulador



Ø 5

Ruota nera Ø 5 cm - attacco rapido
Black castor Ø 5 cm - quick connection
Schwarze Rolle Ø 5 cm - Schnellverbindung
Roulette noir Ø 5 cm - attaque rapide
Rueda negra Ø 5 cm - enganche rapido



Stender "mini" FLAT

"Mini" FLAT garment rail
"Mini" FLACHER Rollständer
Penderie "Mini" PLANT
"Mini" Perchero PLANO

CODICE	A	Ø	↕	
ST25600	60	5	RN1	NEW

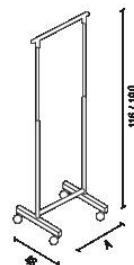

Stender pieghevole tubo quadro

Fold-away rail, square section
Reiserollständer, Vierkantröhr
Penderie pliable, pied tube carré
Perchero plegable, tubo cuadrado

CODICE	A	b	↕	⊥
214/80	140	8	—	—
ST21214	140	8	RN1	■
ST21214/S	140	8	RN1	■
ST15214	100	8	RN1	■
ST15214/S	100	8	RN1	■

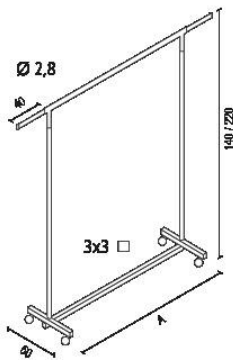

Barra intermedia

Cross bar / Zwischenstange
Barre intermédiaire / Barra intermedia

CODICE	A
209800	140
209900	100

Ripiano

Shelf / Fachböden / Tablette / Estante

CODICE	◆	A	B	C	NEW
GO4010001	NO	140	50	1,8	NEW

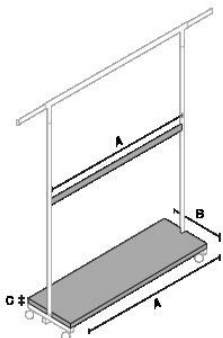

ST21214/S - ST15214/S

in scatola
in carton / im Karton
dans carton / en caja



22

Stender pieghevole

Fold-away rail
Reiserollständer
Penderie pliable
Perchero plegable



Ø 8
Ruota nera Ø 8 cm - attacco filetto
Black castor Ø 8 cm - connection
Schwarze Rolle Ø 8 cm - Schraubgewinde
Roulette noir Ø 8 cm - attaque
Rueda negra Ø 8 cm - filete

RN1
con giunto a scatto
by pull out system
durch Schnäpper / par loquet
mediante regulador



NEW

collection

stender

Stender pieghevole grigio antracite gofrato

Fold-away rail charcoal grey embossed
Reiserollständer grau anthrazit gaufriert
Penderie pliable gris anthracite gaufré
Perchero plegable gris antracita gofrado



RN1

con giunto a scatto
by pull out system
durch Schnäpper / par loquet
mediante regulador



Ø 8

Ruota nera Ø 8 cm - attacco filetto
Black castor Ø 8 cm - connection
Schwarze Rolle Ø 8 cm - Schraubgewinde
Roulette noir Ø 8 cm - attaque
Rueda negra Ø 8 cm - filete



Stender regolabile con giunto a scatto

Fold-away Rail adjustable by pull-out system
Rollständer Höhenverstellung durch Schnäpper
Penderie réglable par loquet
Perchero regulable mediante regulador

CODICE	A	Ø	↕
ST2121402	143	8	RN1 NEW

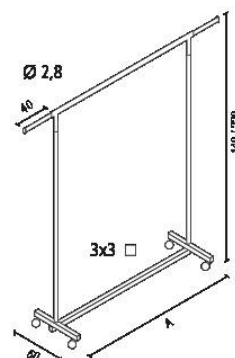

23

Stender pieghevole per rappresentante, fisso

Repsfrend, fixed height
 Reiserollständer, starr
 Penderie pliable pour représentant, hauteur fixe
 Perchero plegable representante, altura fija

CODICE	A	h	h	I
ST28410	95	15	RN2	NEW

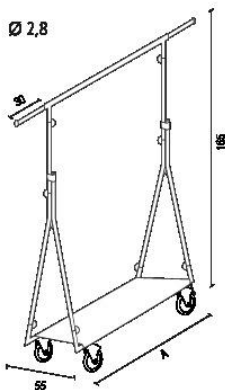

Peso kg 12,7
 Weight Kg 12,7
 Gewicht in Kg 12,7
 Poids Kg 12,7
 Peso Kg 12,7

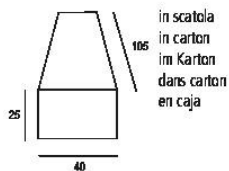

in scatola
 in carton
 im Karton
 dans carton
 en caja



100 x 37 x 22

Elite Stender pieghevole

Elite Fold-away rail
 Elite Reiserollständer
 Elite Penderie pliable
 Elite Perchero plegable

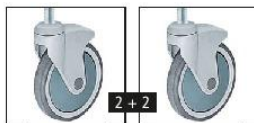

Ø 15
 Ruota grigia Ø 15 cm - attacco filetto
 grey castor Ø 15 cm - connection
 Grau Rolle Ø 15 cm - Schraubgewinde
 Roulette gris Ø 15 cm - attaque
 Rueda gris Ø 15 cm - filete

NEW

collection

stender

Elite Stender pieghevole

Elite Fold-away rail
Elite Reiserollständer
Elite Penderie pliable
Elite Perchero plegable



Stender pieghevole per rappresentante, fisso

Repsfrend, fixed height
Reiserollständer, starr
Penderie pliable pour représentant, hauteur fixe
Perchero plegable representante, altura fija

CODICE	A	Ø	↕	I
ST28411	95	15	RN2	NEW

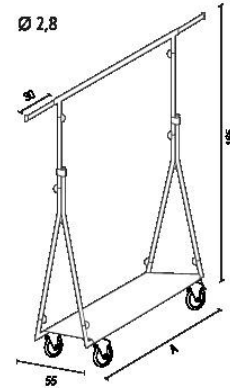

Peso kg 12,7
Weight Kg 12,7
Gewicht in Kg 12,7
Poids Kg 12,7
Peso Kg 12,7

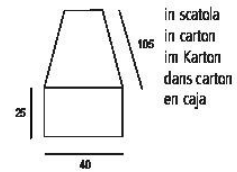

in scatola
in carton
im Karton
dans carton
en caja



100 x 37 x 22

Ø 15

Ruota nera Ø 15 cm - attacco filetto
Black castor Ø 15 cm - connection
Schwarze Rolle Ø 15 cm - Schraubgewinde
Roulette noir Ø 15 cm - attaque
Rueda negra Ø 15 cm - filete



stender

Stender pieghevole regolabile

Fold-away rail, adjustable
Reiserollständer, höhenverstellbar
Penderie pliable réglable
Perchero plegable regulable

CODICE	A	B	Ø	↕	I
210/170/80	80	170	8	RM2	—

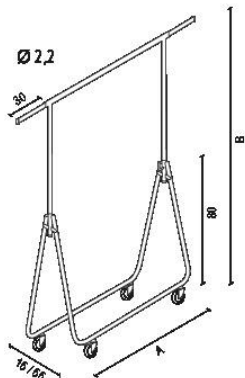

80 x 15

Stender pieghevole

Fold-away rail
Reiserollständer
Penderie pliable
Perchero plegable



Ø 8
Ruota nera Ø 8 cm - attacco filetto
Black castor Ø 8 cm - connection
Schwarze Rolle Ø 8 cm - Schraubgewinde
Roulette noir Ø 8 cm - attaque
Rueda negra Ø 8 cm - filete



RM2
con maniglia
by metallic screw
durch Schraube
par petite poignée
con asas

Stender pieghevole

Fold-away rail
Reiserollständer
Penderie pliable
Perchero plegable

Stender pieghevole regolabile

Fold-away rail, adjustable
Reiserollständer, höhenverstellbar
Penderie pliable réglable
Perchero plegable regulable

CODICE	A	⌀	↕	—
411	85	A10	RN1	—

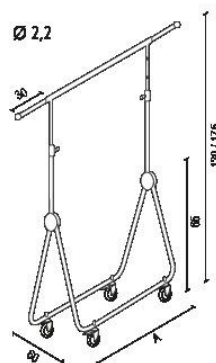

RN1

con giunto a scatto / by pull out system
durch Schnäpper / par loquet
mediante regulador



Ø 10

Ruota grigia Ø 10 cm - attacco filetto
grey castor Ø 10 cm - connection
Grau Rolle Ø 10 cm - Schraubgewinde
Roulette gris Ø 10 cm - attaque
Rueda gris Ø 10 cm - filete



96 x 80

stender

Stender pieghevole per rappresentante, fisso

Repsfrend, fixed height
 Reiserollständer, starr
 Penderie pliable pour représentant, hauteur fixe
 Perchero plegable representante, altura fija

CODICE	A	b	↕	I
410	100	8	—	—
410/S	100	8	—	—
410/100	100	10	—	—
410/100/S	100	10	—	—
410M	100	8	—	—

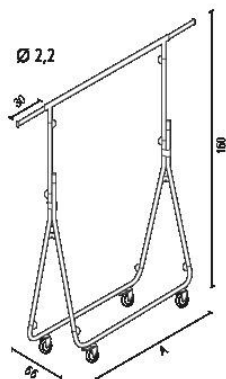

410M
 Maniglia
 Handle
 Handgriff
 Poignée
 Asas

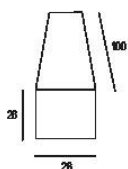

410/S
410/100/S
 in scatola
 in carton
 im Karton
 dans carton
 en caja



98 x 26

Stender pieghevole

Fold-away rail
 Reiserollständer
 Penderie pliable
 Perchero plegable



Ø 8

Ruota nera Ø 8 cm - attacco filetto
 Black castor Ø 8 cm - connection
 Schwarze Rolle Ø 8 cm - Schraubgewinde
 Roulette noir Ø 8 cm - attaque
 Rueda negra Ø 8 cm - filete



Ø 10

Ruota nera Ø 10 cm - attacco filetto
 Black castor Ø 10 cm - connection
 Schwarze Rolle Ø 10 cm - Schraubgewinde
 Roulette noir Ø 10 cm - attaque
 Rueda negra Ø 10 cm - filete

Stender pieghevole

Fold-away rail
Reiserollständer
Penderie pliable
Perchero plegable



RV1

con volantino
by black screw
durch Schwarze Schraube
par visse noir
con palomilla



Ø 8

Ruota nera Ø 8 cm - attacco filetto
Black castor Ø 8 cm - connection
Schwarze Rolle Ø 8 cm - Schraubgewinde
Roulette noir Ø 8 cm - attache
Rueda negra Ø 8 cm - filete



Ø 10

Ruota nera Ø 10 cm - attacco filetto
Black castor Ø 10 cm - connection
Schwarze Rolle Ø 10 cm - Schraubgewinde
Roulette noir Ø 10 cm - attache
Rueda negra Ø 10 cm - filete



Stender pieghevole per rappresentante,
regolabile

Repsfrend, adjustable
Reiserollständer, höhenverstellbar
Penderie pliable pour représentant, hauteur réglable
Perchero plegable representante, regulable

CODICE	A	b	↕	↳
410/R	100	8	RV1	—
410/R100	100	10	RV1	—
410/R100S	100	10	RV1	—

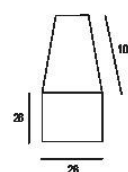
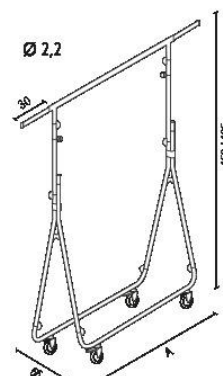

410/R100S

in scatola
in carton
im Karton
dans carton
en caja



98 x 26

stender

Stender doppio regolabile

Double garment rail, adjustable
Doppelständer, höhenverstellbar
Penderie double réglable
Perchero doble regulable

CODICE	A	Ø	↕	I
204	140	—	RS2	■
204R50	140	5	RS2	■
204R80	140	8	RS2	■

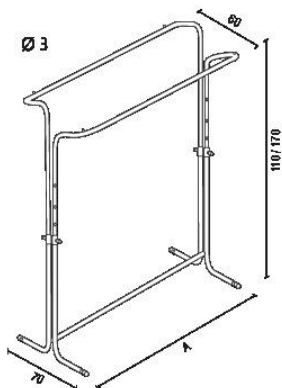

Barra intermedia con prolunghe

Cross bar with side extension arms
Zwischenstange mit Armen
Barre intermédiaire avec bras
Barra intermedia con brazos

CODICE	A
204600	140

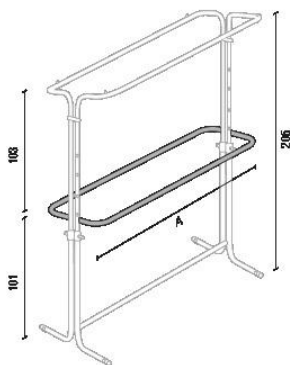

Stender doppio

Double garment rail
Doppelständer
Penderie double
Perchero doble



Ø 5
Ruota nera Ø 5 cm - attacco filetto
Black castor Ø 5 - connection
Schwarze Rolle Ø 5 - Schraubgewinde
Roulette noir Ø 5 - attaque
Rueda negra Ø 5 - filete



Ø 8
Ruota nera Ø 8 cm - attacco filetto
Black castor Ø 8 cm - connection
Schwarze Rolle Ø 8 cm - Schraubgewinde
Roulette noir Ø 8 cm - attaque
Rueda negra Ø 8 cm - filete

RS2
con giunto a scatto
by pull out system
durch Schnäpper
par loquet
mediante regulador



Stender doppio

Double garment rail
Doppelständer
Penderie double
Perchero doble



RM1

con maniglia
by metallic screw
durch Schraube
par petite poignée
con asas



Stender doppio regolabile

Double garment rail, adjustable
Doppelständer, höhenverstellbar
Penderie double réglable
Perchero doble regulable

CODICE	A	⌀	↕	I
ST20510	120	—	RM1	■

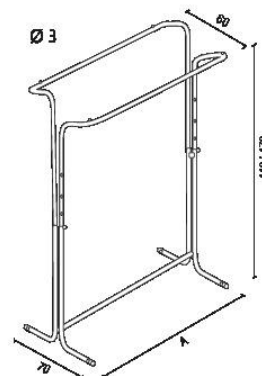

Barra intermedia con prolunghe

Cross bar with side extension arms
Zwischenstange mit Armen
Barre intermédiaire avec bras
Barra intermedia con brazos

CODICE	A
ST205600	120

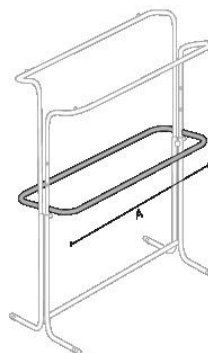

stender

Stender doppia barra regolabile

Twin top rail, adjustable
 Rolständer mit 2 Tragestangen, höhenverstellbar
 Penderie double barre réglable
 Perchero doble barra regulable

CODICE	A	b	↕	I
ST209R80B	143	8	RN1	—

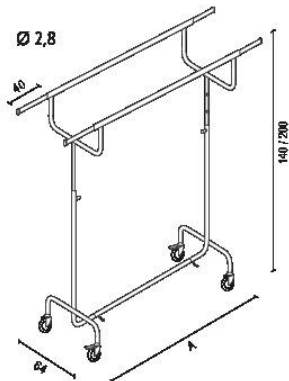

Stender doppio

Double garment rail
 Doppelständer
 Penderie double
 Perchero doble



Ø 8
 Ruota nera Ø 8 cm - attacco rapido
 Black castor Ø 8 cm - quick connection
 Schwarze Rolle Ø 8 cm - Schnellverbindung
 Roulette noir Ø 8 cm - attaque rapide
 Rueda negra Ø 8 cm - enganche rapido

RN1
 con giunto a scatto
 by pull out system
 durch Schnäpper
 par loquet
 mediante regulador



Stender semicircolare

Semicircular garment rail
Halbkreis-Ständer
Penderie semicirculaire
Perchero semicircular



Stender semicircolare

Semicircular garment rail / Halbkreis-Ständer
Penderie semicirculaire / Perchero semicircular

CODICE	B	⌀	↕	⊥
207/120	120	—	—	—
207/150	150	—	—	—

Ø 2,8

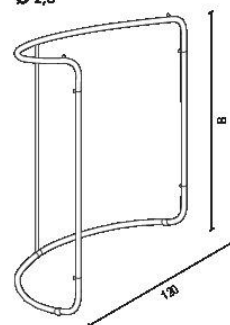

33

stender

Stender accatastabile tubo quadro

Stackable garment rail, square section
 Rollständer, stapelbar, Vierkantröhre
 Penderie empilable, pied tube carré
 Perchero amontenable, tubo cuadrado

CODICE	A	Ø	↕	I
213/80CR	130	8	—	—

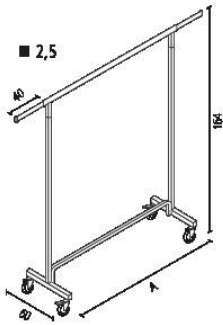

Stender accatastabile

Stackable garment rail
 Rollständer, stapelbar
 Penderie empilable
 Perchero amontenable



Ø 8
 Ruota nera Ø 8 cm - attacco filetto
 Black castor Ø 8 cm - connection
 Schwarze Rolle Ø 8 cm - Schraubgewinde
 Roulette noir Ø 8 cm - attaque
 Rueda negra Ø 8 cm - filete

Stender accatastabile

Stackable garment rail
 Rollständer, stapelbar
 Penderie empilable
 Perchero amontenable



Ø 8
 Ruota nera Ø 8 cm - attacco rapido
 Black castor Ø 8 cm - quick connection
 Schwarze Rolle Ø 8 cm - Schnellverbindung
 Roulette noir Ø 8 cm - attaque rapide
 Rueda negra Ø 8 cm - enganche rapido



Stender a "Z" fisso

"Z" fix garment rail / "Z" Rollständer, starr
 Penderie fixe "Z" / Perchero fijo "Z"

CODICE	A	b	↕	⊥
209/Z/80	143	8	—	—

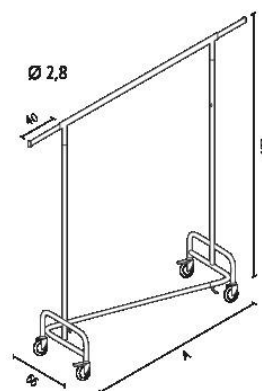

Stender

Garment rail / Rollständer /
Penderie / Perchero

CODICE	A	⊕	⊖	◆
ST251300	100	—	—	CL NEW
ST251309	100	—	—	BN NEW

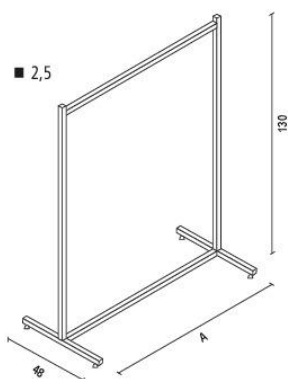

Coppia mensole

Shelf brackets / Konsole Paar / Consoles / Cartelas

CODICE	A	◆
ST251320	30	CL NEW
ST251329	30	BN NEW

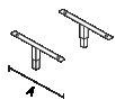

Ripiano

Shelf / Boden / Tablette / Estante

CODICE	A	B	C	◆
G04010009	100	40	1,8	BN

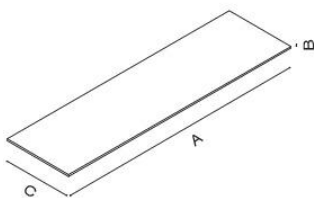

36

Stender tubo quadro

Square tube garment rail
Rollständer, Vierkantröhr
Penderie pied tube carré
Perchero tubo cuadrado



piantane

Piantana a 2 braccia dritte, regolabile

Merchandising unit with 2 straight arms, adjustable
Konfektionsständer mit 2 geraden Armen,
höhenverstellbar / Portant 2 bras droits, réglable
Perchero 2 brazos rectos, regulable

CODICE	A	⊗	↕
ST27500	70	—	RS4

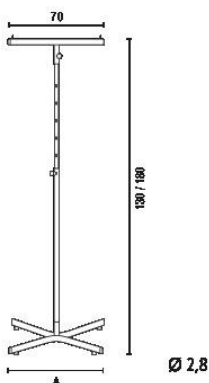

Piantana a 2 braccia (1 dritta e 1 inclinata), regolabile

Merchandising unit with 2 arms (1 straight and 1 sloping), adjustable
Konfektionsständer mit 2 Armen (1 geraden und 1 Schrägarm), höhenverstellbar
Portant 2 bras (1 droit et 1 incliné), réglable
Perchero 2 brazos (1 brazo recto y 1 inclinado), regulable, cromado

CODICE	A	⊗	↕
ST27550	70	—	RS4

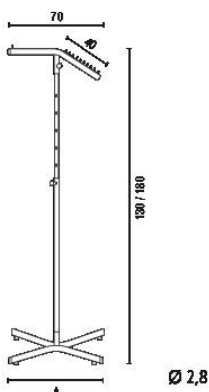

Ruota senza freno Ø 5 cm

Ruota cromata Ø 5 cm - attacco filetto
Chromium plated castor Ø 5 cm - connection
Chrom überzogene Rolle Ø 5 cm - Schraubgewinde
Roulette chromée Ø 5 cm - attaque
Rueda cromada Ø 5 cm - filete

CODICE	Ø
31020	5



Piantane tubo tondo

Merchandising units, round section
Abhängeständer, Rundrohr
Portants, tube ronde
Percheras, tubo redondo



RS4
con volantino
by black screw
durch schwarze Schraube
par visse noir
con palomilla

Piantana tubo tondo

Merchandising unit, round section
 Abhängeständer, Rundrohr
 Portant, tube ronde
 Perchero, tubo redondo



RS4
 con volantino
 by black screw
 durch schwarze Schraube
 par visse noir
 con palomilla

Piantana a 2 braccia inclinate, regolabile

Merchandising unit with 2 sloping arms, adjustable
 Abhängeständer mit 2 Schrägarmen, höhenverstellbar
 Portant 2 bras inclinés, réglable
 Perchero 2 brazos inclinados, regulable

CODICE	A	⊕	⊕
ST27600	70	—	RS4

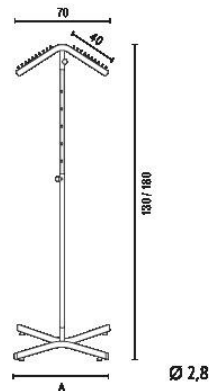

Ruota senza freno Ø 5 cm

Ruota cromata Ø 5 cm - attacco filetto
 Chromium plated castor Ø 5 cm - connection
 Chrom überzogene Rolle Ø 5 cm - Schraubgewinde
 Roulette chromée Ø 5 cm - attaque
 Rueda cromata Ø 5 cm - filete

CODICE	Ø
31020	5



piantane

Piantana a 4 braccia inclinate, regolabile

4-waterfall arms merchandising unit, adjustable
Kreuzständer mit 4 Schrägarms, höhenverstellbar
Portant multi-bras, 4 bras inclinés, réglable
Perchero con 4 brazos inclinados, regulable

CODICE	A	⊗	↕
274	75	—	RS3

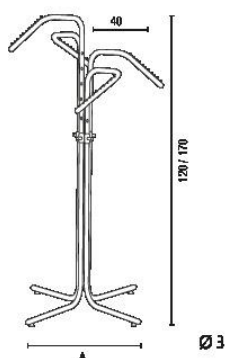

Piantane tubo tondo

Merchandising units, round section
Abhängeständer, Rundrohr
Portants, tube ronde
Percheros, tubo redondo



Ruota Ø 5 cm

Ruota nera Ø 5 cm - attacco filetto
Black castor Ø 5 - connection
Schwarze Rolle Ø 5 - Schraubgewinde
Roulette noir Ø 5 - attaque
Rueda negra Ø 5 - filete



CODICE	Ø
31021	5



CODICE	Ø
31021/F	5



RS3

con giunto a scatto
by pull out system
durch Schnäpper
par loquet
mediante regulador

Piantane tubo tondo

Merchandising units, round section
Abhängeständer, Rundrohr
Portants, tube ronde
Percheras, tubo redondo



RF1
con fascetta
by locking lever
durch Schlauchklemme
par collier serre-tube
con palanca de fijación



Ø 5
Ruota nera Ø 5 cm - attacco rapido
Black castor Ø 5 cm - quick connection
Schwarze Rolle Ø 5 cm - Schnellverbindung
Roulette noir Ø 5 cm - attaque rapide
Rueda negra Ø 5 cm - enganche rapido



Piantana a 3 braccia inclinate,
base 5 ruote, regolabile

3-waterfall arms display rail, base with 5 castors,
adjustable / Abhängeständer mit 3 Schrägar-
men, mit 5 Rollen, höhenverstellbar / Portant 3 bras
inclinés, base à 5 pieds avec roulettes, réglable
Perchero 3 brazos inclinados, base 5 pies
con ruedas, regulable

CODICE	A	⌀	↕
482	70	5	RF1

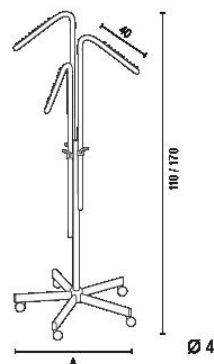

Piantana a 3 braccia dritte,
base 5 ruote, regolabile

3-straight arms display rail, base with 5 castors,
adjustable / Abhängeständer mit 3 geraden Armen,
mit 5 Rollen, höhenverstellbar
Portant 3 bras droit, base à 5 pieds avec roulettes,
réglable
Perchero 3 brazos rectos, base 5 pies con ruedas,
regulable

CODICE	A	⌀	↕
483	70	5	RF1

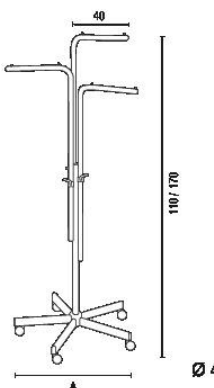

piantane

Piantana a 4 braccia piegate-inclinate, base 5 ruote, regolabile

4-waterfall cranked arms display rail, base with 5 castors, adjustable / Abhängeständer mit 4 gewinkelten Schrägarmen, mit 5 Rollen, höhenverstellbar
Portant 4 bras inclinés pliés, base à 5 pieds avec roulettes, réglable / Perchero 4 brazos inclinados, base 5 pies con ruedas, regulable

CODICE	A	h	⌀
484	70	5	RF1

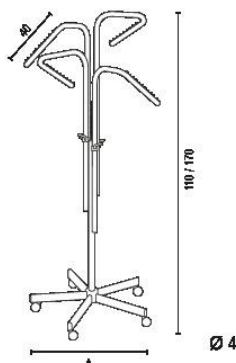

Piantana a 4 braccia piegate-dritte, base 5 ruote, regolabile

4-cranked straight arms display rail, base with 5 castors, adjustable / Abhängeständer mit 4 geraden Armen, gewinkelt, mit 5 Rollen, höhenverstellbar
Portant 4 bras droits pliés, base à 5 pieds avec roulettes, réglable / Perchero 4 brazos rectos, base 5 pies con ruedas, regulable

CODICE	A	h	⌀
485	70	5	RF1

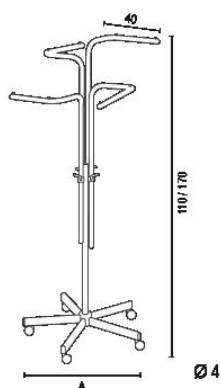

Piantane tubo tondo

Merchandising units, round section
Abhängeständer, Rundrohr
Portants, tube ronde
Percheros, tubo redondo



RF1
con fascetta
by locking lever
durch Schlauchklemme
par collier serre-tube
con palanca de fijación



Ø 5
Ruota nera Ø 5 cm - attacco rapido
Black castor Ø 5 cm - quick connection
Schwarze Rolle Ø 5 cm - Schnellverbindung
Roulette noir Ø 5 cm - attaque rapide
Rueda negra Ø 5 cm - enganche rapido

Piantana tubo tondo

Merchandising unit, round section
 Abhängeständer, Rundrohr
 Portant, tube ronde
 Perchero, tubo redondo



RF1

con fascetta
 by locking lever
 durch Schlauchklemme
 par collier serre-tube
 con palanca de fijación



Ø 5

Ruota nera Ø 5 cm - attacco rapido
 Black castor Ø 5 cm - quick connection
 Schwarze Rolle Ø 5 cm - Schnellverbindung
 Roulette noir Ø 5 cm - attaque rapide
 Rueda negra Ø 5 cm - enganche rapido



Piantana a 3 braccia con anelli portacinture, base 5 ruote, regolabile

Display Stand, 3 arm carousel top, base with 5
 castors, adjustable / Abhängeständer, mit 3 Armen
 mit Hakenringen, mit 5 Rollen, höhenverstellbar
 Portant 3 tournoquets, base à 5 pieds avec roulettes,
 réglable / Perchero, 3 brazos con estrellas giratorias,
 base 5 pies con ruedas, regulable

CODICE	A	h	↕
486	70	5	RF1

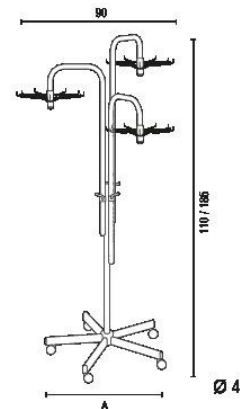

**Piantana portacinture/cravatte,
base 5 ruote, regolabile**

Display stand, 12/20 arm carousel, base with 5 castors, adjustable / Gürtel-Fouland und Kravattenszänder, mit 5 Rollen, höhenverstellbar / Portant porte-cravates, 1 ou 2 tourniquets à 12/20 bras, base à 5 pieds avec roulettes, réglable / Perchero para corbatas y cinturones, base 5 pies, regulable

CODICE	A	⌀	↕
266/1	67	5	RP1
266/2	67	5	RP1 NEW

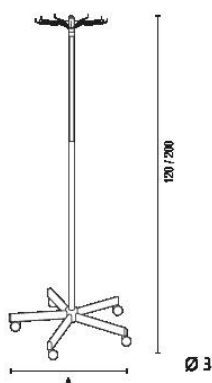

Anello portacinture con 12 braccetti \varnothing 33 cm

12 arm carousel \varnothing 33 cm / Ring für Gürtel mit 12 Haken \varnothing 33 cm / Tourniquet porte-cravates à 12 bras \varnothing 33 cm / Aro para portacinturones 12 brazos \varnothing 33 cm



CODICE	⌀
266/P	33

Anello portacinture con 20 braccetti \varnothing 55 cm

20 arm carousel \varnothing 55 cm / Ring für Gürtel mit 20 Haken \varnothing 55 cm / Tourniquet porte-cravates à 20 bras \varnothing 55 cm / Aro para portacinturones 20 brazos \varnothing 55 cm



CODICE	⌀
266/G	55



Piantana tubo tondo

Merchandising unit, round section
Abhängeständer, Rundrohr
Portant, tube ronde
Perchero, tubo redondo



⌀ 5
Ruota nera \varnothing 5 cm - attacco rapido
Black castor \varnothing 5 cm - quick connection
Schwarze Rolle \varnothing 5 cm - Schnellverbindung
Roulette noir \varnothing 5 cm - attaque rapide
Rueda negra \varnothing 5 cm - enganche rapido

RP1
con pulsante
by push button
durch Knopf
par bouton-poussoir
con botón



NEW

collection

piantane

Piantana tubo tondo

Merchandising unit, round section
Abhängeständer, Rundrohr
Portant, tube ronde
Perchero, tubo redondo



RP1

con pulsante
by push button
durch Knopf
par bouton-poussoir
con botón



Ø 5

Ruota nera Ø 5 cm - attacco rapido
Black castor Ø 5 cm - quick connection
Schwarze Rolle Ø 5 cm - Schnellverbindung
Roulette noir Ø 5 cm - attaque rapide
Rueda negra Ø 5 cm - enganche rapido



Piantana porta borse/cinture

Bag/belt display stand
Ständer für Taschen/Gürtel
Portant port-sac/cinture
Perchero para bolsos y cinturones

CODICE	A	Ø	↕	
ST26510	67	5	RP1	NEW

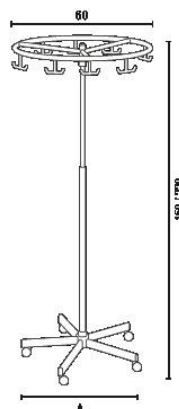

Anello Ø 60 cm per piantana circolare

Circular carousel top Ø 60 cm for circular rail
Ring Ø 60 cm für Ringständer
Cercle Ø 60 cm pour penderie ronde
Aro Ø 60 cm para perchero redondo

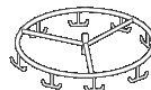

CODICE

SL99926510600	NEW
---------------	-----

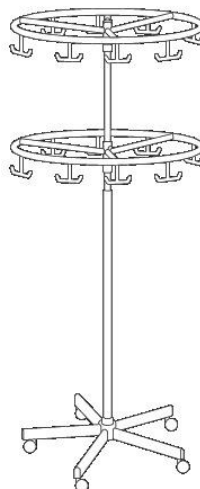

47

piantane

Piantana circolare Ø 73 cm, base 5 ruote, regol.

Circular rail Ø 73 cm, base with 5 castors, adjustable
 Ringständer Ø 73 cm, mit 5 Rollen, höhenverstellbar
 Portant ronde Ø 73 cm, base à 5 pieds avec
 roulettes, réglable / Perchero redondo Ø 73 cm,
 base 5 pies, regulable

CODICE	A		
265/70	67	5	RP1

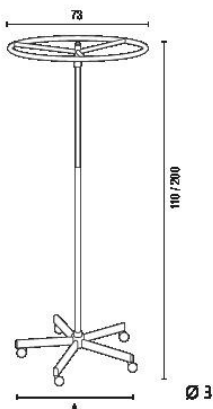

Anello Ø 73 cm per piantana circolare

Circular carousel top Ø 73 cm for circular rail
 Ring Ø 73 cm für Ringständer
 Cercle Ø 73 cm pour penderie ronde
 Aro Ø 73 cm para perchero redondo



CODICE	Ø
265750	73



Piantana tubo tondo

Merchandising unit, round section
 Abhängeständer, Rundrohr
 Portant, tube ronde
 Perchero, tubo redondo



Ø 5
 Ruota nera Ø 5 cm - attacco rapido
 Black castor Ø 5 cm - quick connection
 Schwarze Rolle Ø 5 cm - Schnellverbindung
 Roulette noir Ø 5 cm - attaque rapide
 Rueda negra Ø 5 cm - enganche rapido



RP1
 con pulsante
 by push button
 durch Knopf
 par bouton-poussoir
 con botón

Piantana tubo tondo

Merchandising unit, round section
 Abhängeständer, Rundrohr
 Portant, tube ronde
 Perchero, tubo redondo



RS6

con giunto a scatto
 by pull out system
 durch Schnäpper
 par loquet
 mediante regulador



Ø 5

Ruota nera Ø 5 cm - attacco rapido
 Black castor Ø 5 cm - quick connection
 Schwarze Rolle Ø 5 cm - Schnellverbindung
 Roulette noir Ø 5 cm - attaque rapide
 Rueda negra Ø 5 cm - enganche rapido



Ø 8

Ruota nera Ø 8 cm - attacco rapido
 Black castor Ø 8 cm - quick connection
 Schwarze Rolle Ø 8 cm - Schnellverbindung
 Roulette noir Ø 8 cm - attaque rapide
 Rueda negra Ø 8 cm - enganche rapido



Piantana circolare Ø 80 cm, base 5 ruote, regol.

Circular rail Ø 80 cm, base with 5 castors, adjustable
 Ringsänder Ø 80 cm, mit 5 Rollen, höhenverstellbar
 Portant ronde Ø 80 cm, base à 5 pieds avec roulettes,
 réglable / Perchero redondo Ø 80 cm, base 5 pies, regulable

CODICE	A	h	⇕
ST26800	80	5	—
268	80	5	RS6
268/80	80	8	RS6

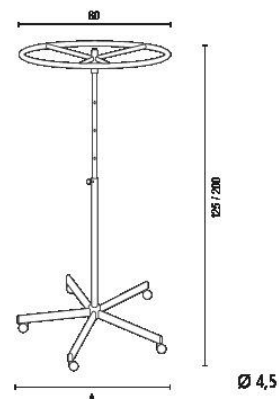

Supporto portacartello

Support for card holder / Plakathalter / Support
 pour porte-étiquette / Soporte para porta-precio

CODICE

268800



piantane

Piantana circolare Ø 100 cm, base 5 ruote, regol.

Circular rail Ø 100 cm, base with 5 castors, adjustable
 Ringständer Ø 100 cm, mit 5 Rollen, höhenverstellbar
 Portant ronde Ø 100 cm, base à 5 pieds avec roulettes,
 réglable / Perchero redondo Ø 100 cm, base 5 pies, regulable

CODICE	A	h	⊗
269	90	5	RS6
269/80	90	8	RS6

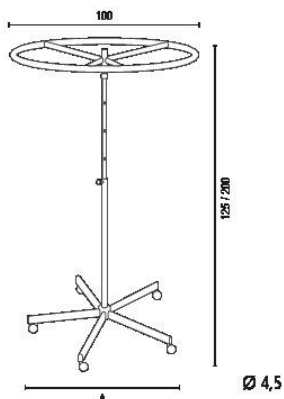

Supporto portacartello

Support for card holder / Plakathalter / Support
 pour porte-étiquette / Soporte para porta-precio



CODICE

268800

Piantana tubo tondo

Merchandising unit, round section

Abhängeständer, Rundrohr

Portant, tube ronde

Perchero, tubo redondo



Ø 5

Ruota nera Ø 5 cm - attacco rapido
 Black castor Ø 5 cm - quick connection
 Schwarze Rolle Ø 5 cm - Schnellverbindung
 Roulette noir Ø 5 cm - attaque rapide
 Rueda negra Ø 5 cm - enganche rapido



Ø 8

Ruota nera Ø 8 cm - attacco rapido
 Black castor Ø 8 cm - quick connection
 Schwarze Rolle Ø 8 cm - Schnellverbindung
 Roulette noir Ø 8 cm - attaque rapide
 Rueda negra Ø 8 cm - enganche rapido

RS6

con giunto a scatto
 by pull out system
 durch Schnapper
 par loquet
 mediante regulador



Piantana tubo tondo

Merchandising unit, round section
 Abhängeständer, Rundrohr
 Portant, tube ronde
 Perchero, tubo redondo



Ø 5

Ruota nera Ø 5 cm - attacco rapido
 Black castor Ø 5 cm - quick connection
 Schwarze Rolle Ø 5 cm - Schnellverbindung
 Roulette noir Ø 5 cm - attaque rapide
 Rueda negra Ø 5 cm - enganche rapido



Piantana a spirale con 43 sfere,
 base 5 ruote

Spiral rail 43 pegs, base with 5 castors
 Spiralständer mit 43 Anschlagkugeln, mit 5 Rollen
 Portant spirale avec 43 pivots, base à 5 pieds
 avec roulettes / Perchero espiral con 43 pivotes,
 base 5 ruedas

CODICE	A	h	↕
468/1	67	5	—

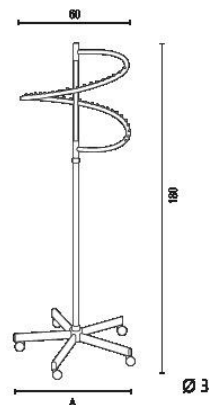

Piantana portacappelli

base 5 ruote

Hat display, base with 5 castors

Hutständer, mit 5 Rollen

Portant à chapeaux, base à 5 pieds avec roulettes

Expositor sombreros, base 5 ruedas

CODICE	A			
ST11030	55	5	—	NEW

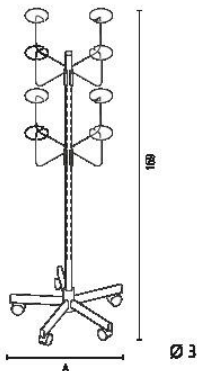

Set di 4 supporti per piantana porta-cappelli

Set of 4 supports for hat display

Set mit 4 Haltern für Hutständer

Set de 4 supports pour portant à chapeaux

Set de 4 soportes para expositor sombreros

CODICE	A	
SL99911030700	-	NEW



Piantana tubo tondo

Merchandising unit, round section

Abhängeständer, Rundrohr

Portant, tube ronde

Perchero, tubo redondo



Ø 5

Ruota nera Ø 5 cm - attacco rapido
 Black castor Ø 5 cm - quick connection
 Schwarze Rolle Ø 5 cm - Schnellverbindung
 Roulette noir Ø 5 cm - attaque rapide
 Rueda negra Ø 5 cm - enganche rapido

NEW

collection

piantane

Piantana tubo tondo

Merchandising unit, round section
Abhängeständer, Rundrohr
Portant, tube ronde
Perchero, tubo redondo



Piantana porta-appendini

Hangers floor based unit
Kleiderbügelständer
Piétement pour cintres
Perchero perchas

CODICE	A	h	h	
ST80130	35	—	—	NEW

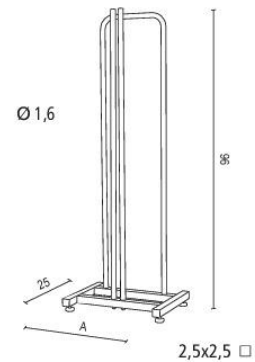



53

piantane

Piantana portalingerie a 16 braccia

Lingerie stand 16 arms
 Untenwäscheständer mit 16 Armen
 Portant pour lingerie avec 16 bras
 Perchero linceria con 16 brazos

CODICE	A		
277	70	—	—

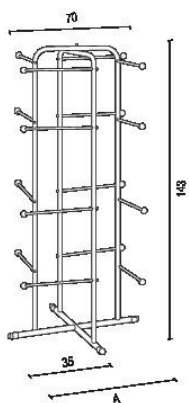

base Ø 2,8 archetti Ø 2

Piantana tubo tondo

Merchandising unit, round section
 Abhängeständer, Rundrohr
 Portant, tube ronde
 Perchero, tubo redondo



Piantana tubo quadro

Merchandising unit, square section
 Abhängeständer, Vierkantröhr
 Portant, tube carré
 Perchero, tubo cuadrado



Piantana portalingerie a 4 braccia piegate

Four-tier double "Z" based unit
 Dessousständer mit 4 Armen
 Portant lingerie avec 4 bras
 Perchero lencería 4 brazos

CODICE	A	⌀	↕
515	40	—	—

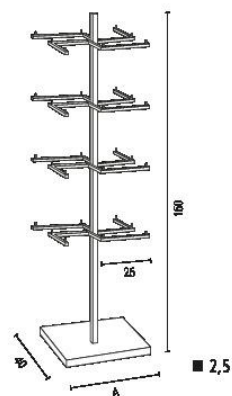

piantane

Piantana a 2 montanti

2-way floor based unit
Fuss mit 2 Standpfosten
Piétement 2 éléments
Base a 2 montantes

CODICE	A	Ø	↕
502	40	—	—

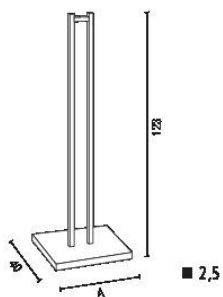

Piantana tubo quadro

Merchandising unit, square section
Abhängeständer, Vierkantröhr
Portant, tube carré
Perchero, tubo cuadrado



Piantane tubo quadro

Merchandising units, square section
 Abhängeständer, Vierkantröhr
 Portants, tube carré
 Percheros, tubo cuadrado



Piantana a 4 montanti

4-way floor based unit
 Fuss mit 4 Standpfosten
 Piétement 4 éléments
 Base a 4 montantes

CODICE	A	Ø	⇄
506	80	—	—
506R50	80	5	—

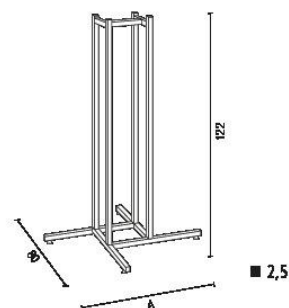

Ø 5

Ruota nera Ø 5 cm - attacco filetto
 Black castor Ø 5 - connection
 Schwarze Rolle Ø 5 - Schraubgewinde
 Roulette noir Ø 5 - attaque
 Rueda negra Ø 5 - filete



complementi per piantane tubo quadro

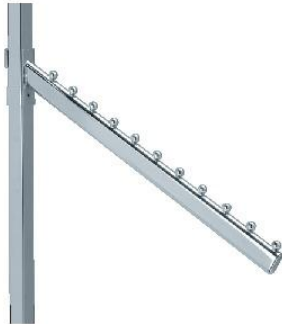

Braccio intermedio inclinato

Add-on waterfall arm / schräger Zwischenarm
Bras intermédiaire incliné / Brazo inclinado

CODICE

ST00549



Braccio intermedio dritto

Add-on straight arm / gerader Zwischenarm
Bras intermédiaire droit / Brazo recto

CODICE **A**

ST00550 40



Braccio dritto

Straight arm
gerader Einsatz
Bras droit
Brazo recto

CODICE **A**

ST00551 40



Braccio a gradino

Stepped arm / Stufeneinsatz
Bras à gradin / Brazo escalon

CODICE

ST00552



Braccio inclinato

Sloping arm
Schrägeinsatz
Bras incliné
Brazo inclinado

CODICE **A**

ST00553 46



Braccio piegato-inclinato sinistro

Waterfall cranked arm, left
schräger Einsatz gewinkelt, rechts
Bras croix incliné à droite
Brazo derecho plegado

CODICE

ST00560





Stender Collection FID

Articolo Item Artikel Article Codigo	Descrizione / Description / Beschreibung / Description / Descripcion	CHF - Prezzo unitario - Price per piece - Preis pro Stück - Prix par pièce - Precio para unidad	Confezione Pack Abnahme Unité Unidad
STENDER / RAILS / KONFEKTIONSSTÄNDER / PENDERIES / PERCHEROS			
Accessori per stender / Accessories for garment gail / Zubehör für Rollständer / Accessoires pour penderie / Accesorios para perchero			
406/I	Broche inclinata per barra tubo ovale Sloping arm for oval tube Schrärgarm für Ovalrohrstange Bras incliné pour barre tube ovale Brazo inclinado para barra oval	21.50	1 pz. 1 ea 1 Stück 1 unité 1 unidad
406/D	Broche dritta per barra tubo ovale Straight arm for oval tube Gerader Arm für Ovalrohrstange Bras droit pour barre tube ovale Brazo recto para barra oval	20.50	1 pz. 1 ea 1 Stück 1 unité 1 unidad
Stender fisso / Fix Garment rail / Rollständer, starr / Penderie fixe / Perchero fijo			
209/E	Stender fisso L 143 cm con ruote Ø 5 cm Fix garment rail L 143 cm with castors Ø 5 cm Rollständer L 143 cm mit Rollen Ø 5 cm Penderie L 143 cm avec roulettes Ø 5 cm Perchero fijo L 143 cm con ruedas Ø 5 cm	87.00	1 pz. 1 ea 1 Stück 1 unité 1 unidad
209/E/80	Stender fisso L 143 cm con ruote Ø 8 cm Fix garment rail L 143 cm with castors Ø 8 cm Rollständer L 143 cm mit Rollen Ø 8 cm Penderie L 143 cm avec roulettes Ø 8 cm Perchero fijo L 143 cm con ruedas Ø 8 cm	100.00	1 pz. 1 ea 1 Stück 1 unité 1 unidad
209/E/100	Stender fisso L 143 cm con ruote Ø 10 cm Fix garment rail L 143 cm with castors Ø 10 cm Rollständer L 143 cm mit Rollen Ø 10 cm Penderie L 143 cm avec roulettes Ø 10 cm Perchero fijo L 143 cm con ruedas Ø 10 cm	115.00	1 pz. 1 ea 1 Stück 1 unité 1 unidad
ST00080	Stender fisso L 143 cm con ruote Ø 8 cm Fix garment rail L 143 cm with castors Ø 8 cm Rollständer L 143 cm mit Rollen Ø 8 cm Penderie L 143 cm avec roulettes Ø 8 cm Perchero fijo L 143 cm con ruedas Ø 8 cm	102.00	1 pz. 1 ea 1 Stück 1 unité 1 unidad
209/E/I	Stender fisso L 100 cm con ruote Ø 5 cm Fix garment rail L 100 cm with castors Ø 5 cm Rollständer L 100 cm mit Rollen Ø 5 cm Penderie L 100 cm avec roulettes Ø 5 cm Perchero fijo L 100 cm, con ruedas Ø 5 cm	84.00	1 pz. 1 ea 1 Stück 1 unité 1 unidad
209/E/I/80	Stender fisso L 100 cm con ruote Ø 8 cm Fix garment rail L 100 cm with castors Ø 8 cm Rollständer L 100 cm mit Rollen Ø 8 cm Penderie L 100 cm avec roulettes Ø 8 cm Perchero fijo L 100 cm, con ruedas Ø 8 cm	98.00	1 pz. 1 ea 1 Stück 1 unité 1 unidad
209500/E	Barra intermedia per art. 209/E (con prolunghe) Cross bar for item 209/E (with side extension arms) Zwischenstange für Art. 209/E (mit Armen) Barre intermédiaire pour ref. 209/E (avec bras) Barra intermedia para art. 209/E (con brazos)	31.50	1 pz. 1 ea 1 Stück 1 unité 1 unidad
ST20982	Stender fisso L 143 cm ruote Ø 5 cm, grigio antracite gofrato Fix garment rail L 143 cm, castors Ø 5 cm, charcoal grey embossed Rollständer L 143 cm, Rollen Ø 5 cm, grau anthrazit gaufriert Penderie L 143 cm, roulettes Ø 5 cm, gris anthracite gaufré Perchero fijo L 143 cm, ruedas Ø 5 cm, gris antracita gofrado	115.00	1 pz. 1 ea 1 Stück 1 unité 1 unidad



Stender Collection FID

Articolo Item Artikel Article Codigo	Descrizione / Description / Beschreibung / Descripción/ Descripcion	CHF - Prezzo unitario - Price per piece - Preis pro Stück - Prix par pièce - Precio para unidad	Confezione Pack Abnahme Unité Unidad	
ST3020912	Stender fisso L 143 cm ruote Ø 10 cm, grigio antracite goffrato Fix garment rail L 143 cm, castors Ø 10 cm, charcoal grey embossed Rollständer L 143 cm, Rollen Ø 10 cm, grau anthrazit gaufriert Penderie L 143 cm, roulettes Ø 10 cm, gris anthracite gaufré Perchero fijo L 143 cm, ruedas Ø 10 cm, gris antracita gofrado	173.00	1 pz. 1 ea 1 Stück 1 unité 1 unidad	NEW
ST3020922	Barra intermedia per art. ST3020912 (con prolunghe) Cross bar for item ST3020912 (with side extension arms) Zwischenstange für Art. ST3020912 (mit Armen) Barre intermédiaire pour ref. ST3020912 (avec bras) Barra intermedia para art. ST3020912 (con brazos)	58.00	1 pz. 1 ea 1 Stück 1 unité 1 unidad	NEW
Stender regolabile / Adjustable garment rail / Rollständer, höhenverstellbar / Penderie réglable / Perchero regulable				
161150	Stender "mini" L 83 cm ruote Ø 5 cm regolabile con maniglietta, cromato "Mini" garment rail L 83 cm with castors Ø 5 cm, adjustable by metallic screw, chrome finish "Mini" Rollständer L 83 cm mit Rollen Ø 5 cm, Höhenverstellung durch Schraube, verchromt Penderie "Mini" L 83 cm avec roulettes Ø 5 cm, réglable par petite poignée, chromé "Mini" Perchero L 83 cm ruedas Ø 5 cm regulable con asas, cromado	98.00	1 pz. 1 ea 1 Stück 1 unité 1 unidad	
209/R	Stender L143 cm con ruote Ø 5 cm, regolabile con maniglietta, cromato Garment rail L 143 cm with castors Ø 5 cm, adjustable by metallic screw, chrome finish Rollständer L 143 cm mit Rollen Ø 5 cm, Höhenverstellung durch Schraube, verchromt Penderie L 143 cm avec roulettes Ø 5 cm, réglable par petite poignée, chromé Perchero L 143 cm con ruedas Ø 5 cm, regulable con asas, cromado	98.00	1 pz. 1 ea 1 Stück 1 unité 1 unidad	
209/R/80	Stender L143 cm con ruote Ø 8 cm, regolabile con maniglietta, cromato Garment rail L 143 cm with castors Ø 8 cm, adjustable by metallic screw, chrome finish Rollständer L 143 cm mit Rollen Ø 8 cm, Höhenverstellung durch Schraube, verchromt Penderie L 143 cm avec roulettes Ø 8 cm, réglable par petite poignée, chromé Perchero L 143 cm con ruedas Ø 8 cm, regulable con asas, cromado	113.00	1 pz. 1 ea 1 Stück 1 unité 1 unidad	
ST00180	Stender L143 cm con ruote Ø 8 cm, regolabile con maniglietta, cromato Garment rail L 143 cm with castors Ø 8 cm, adjustable by metallic screw, chrome finish Rollständer L 143 cm mit Rollen Ø 8 cm, Höhenverstellung durch Schraube, verchromt Penderie L 143 cm avec roulettes Ø 8 cm, réglable par petite poignée, chromé Perchero L 143 cm con ruedas Ø 8 cm, regulable con asas, cromado	114.00	1 pz. 1 ea 1 Stück 1 unité 1 unidad	NEW
209/R/I	Stender L 100 cm con ruote Ø 5 cm, regolabile con maniglietta, cromato Garment rail L 100 cm with castors Ø 5 cm, adjustable by metallic screw, chrome finish Rollständer L 100 cm mit Rollen Ø 5 cm, Höhenverstellung durch Schraube, verchromt Penderie L 100 cm avec roulettes Ø 5 cm, réglable par petite poignée, chromé Perchero L 100 cm con ruedas Ø 5 cm, regulable con asas, cromado	95.00	1 pz. 1 ea 1 Stück 1 unité 1 unidad	
209/R//80	Stender L 100 cm con ruote Ø 8 cm, regolabile con maniglietta, cromato Garment rail L 100 cm with castors Ø 8 cm, adjustable by metallic screw, chrome finish Rollständer L 100 cm mit Rollen Ø 8 cm, Höhenverstellung durch Schraube, verchromt Penderie L 100 cm avec roulettes Ø 8 cm, réglable par petite poignée, chromé Perchero L 100 cm con ruedas Ø 8 cm, regulable con asas, cromado	109.00	1 pz. 1 ea 1 Stück 1 unité 1 unidad	
ST01080	Stender L 100 cm con ruote Ø 8 cm, regolabile con maniglietta, cromato Garment rail L 100 cm with castors Ø 8 cm, adjustable by metallic screw, chrome finish Rollständer L 100 cm mit Rollen Ø 8 cm, Höhenverstellung durch Schraube, verchromt Penderie L 100 cm avec roulettes Ø 8 cm, réglable par petite poignée, chromé Perchero L 100 cm con ruedas Ø 8 cm, regulable con asas, cromado	111.00	1 pz. 1 ea 1 Stück 1 unité 1 unidad	NEW
ST209R	Stender L 143 cm con ruote Ø 5 cm, regolabile con giunto a scatto, cromato Garment rail L 143 cm with castors Ø 5 cm adjustable by metallic pin, chrome finish Rollständer L 143 cm mit Rollen Ø 5 cm, Höhenverstellung durch Schnäpper, verchromt Penderie L 143 cm roulettes Ø 5 cm, réglable par loquet, chromé Perchero L 143 cm con ruedas Ø 5 cm, regulable mediante regulador, cromado	105.00	1 pz. 1 ea 1 Stück 1 unité 1 unidad	
ST209R80	Stender L 143 cm con ruote Ø 8 cm, regolabile con giunto a scatto, cromato Garment rail L 143 cm with castors Ø 8 cm, adjustable by metallic pin, chrome finish Rollständer L 143 cm mit Rollen Ø 8 cm, Höhenverstellung durch Schnäpper, verchromt Penderie L 143 cm roulettes Ø 8 cm, réglable par loquet, chromé Perchero L 143 cm con ruedas Ø 8 cm, regulable mediante regulador, cromado	120.00	1 pz. 1 ea 1 Stück 1 unité 1 unidad	
ST209RI	Stender L 100 cm con ruote Ø 5 cm, regolabile con giunto a scatto, cromato Garment rail L 100 cm with castors Ø 5 cm, adjustable by metallic pin, chrome finish Rollständer L 100 cm mit Rollen Ø 5 cm, Höhenverstellung durch Schnäpper, verchromt Penderie L 100 cm roulettes Ø 5 cm, réglable par loquet, chromé Perchero L 100 cm con ruedas Ø 5 cm, regulable mediante regulador, cromado	102.00	1 pz. 1 ea 1 Stück 1 unité 1 unidad	
ST209RI80	Stender L 100 cm con ruote Ø 8 cm, regolabile con giunto a scatto, cromato Garment rail L 100 cm with castors Ø 8 cm, adjustable by metallic pin, chrome finish Rollständer L 100 cm mit Rollen Ø 8 cm, Höhenverstellung durch Schnäpper, verchromt Penderie L 100 cm roulettes Ø 8 cm, réglable par loquet, chromé Perchero L 100 cm con ruedas Ø 8 cm, regulable mediante regulador, cromado	117.00	1 pz. 1 ea 1 Stück 1 unité 1 unidad	
209800	Barra intermedia L 140 cm Cross bar L 140 cm Zwischenstange L 140 cm Barre intermédiaire L 140 cm Barra intermedia L 140 cm	27.50	1 pz. 1 ea 1 Stück 1 unité 1 unidad	



Stender Collection FID

Articolo Item Artikel Article Codigo	Descrizione / Description / Beschreibung / Déscription/ Descripcion	CHF - Prezzo unitario - Price per piece - Preis pro Stück - Prix par pièce - Precio para unidad	Confezione Pack Abnahme Unité Unidad	
209900	Barra intermedia L 100 cm Cross bar L 100 cm Zwischenstange L 100 cm Barre intermédiaire L 100 cm Barra intermedia L 100 cm	27.50	1 pz. 1 ea 1 Stück 1 unité 1 unidad	
211	Stender moderno lusso L 140 cm con ruote Ø 8 cm regolabile con giunto a scatto, tubo 30 mm, cromato Garment rail top version L 140 cm with castors Ø 8 cm adjustable by metallic pin, tube 30 mm, chrome finish Rollständer Top Version L 140 cm mit Rollen Ø 8 cm, Höhenverstellung durch Schnäpper, Rohr 30 mm, verchromt Penderie modèle luxe L 140 cm avec roulettes Ø 8 cm, réglable par loquet, tube 30 mm, chromé Perchero version lujo L 140 cm con ruedas Ø 8 cm, regulable mediante regulador, tubo 30 mm, cromado	199.00	1 pz. 1 ea 1 Stück 1 unité 1 unidad	
ST14550	Stender porta-costumi, tubo quadro con ruote Ø 8 cm Swimwear stand, square section tube with castors Ø 8 cm Badeanzugständer, vierkanthor mit Rollen Ø 8 cm Penderie pour maillots de bain, tube carré avec roulettes Ø 8 cm Perchero para bañadores, tubo cuadrado con ruedas Ø 8 cm	180.00	1 pz. 1 ea 1 Stück 1 unité 1 unidad	NEW
ST80120	Stender porta-appendini 4 barre appenderia, con ruote Ø 5 cm Hanging rail 4 bars, with castors Ø 5 cm Kleiderbügelständer mit 4 Querstangen, mit Rollen Ø 5 cm Penderie pour cintres 4 barres, avec roulettes Ø 5 cm Perchero perchas 4 barras, con ruedas Ø 5 cm	124.00	1 pz. 1 ea 1 Stück 1 unité 1 unidad	NEW
ST80120/S	Stender porta-appendini 4 barre appenderia, con ruote Ø 5 cm, in scatola Hanging rail 4 bars, with castors Ø 5 cm, packed in carton Kleiderbügelständer mit 4 Querstangen, mit Rollen Ø 5 cm, im Karton Penderie pour cintres 4 barres, avec roulettes Ø 5 cm, dans carton Perchero perchas 4 barras, con ruedas Ø 5 cm, en caja	132.00	1 pz. 1 ea 1 Stück 1 unité 1 unidad	NEW
ST8012010	Set di 4 barre appenderia per stender porta-appendini Set of 4 bars for Hanging rail Set mit 4 Querstangen für Kleiderbügelständer Set de 4 barres pour penderie cintres Set de 4 barras para perchero perchas	29.00	1 pz. 1 ea 1 Stück 1 unité 1 unidad	NEW
ST28400	Espositore portascarpe con traverso intermedio, cromato Shoe Stand with cross bar, chrome finish Schuhverkaufsständer mit Zwischenquerstange (mit Zwischenstab), verchromt Présentoir chaussures avec entretoise intermédiaire, chromé Perchero para zapatos con barra intermedia, cromado	230.00	1 pz. 1 ea 1 Stück 1 unité 1 unidad	
Stender pieghevole / Fold-away Rail / Rollständer / Penderie pliable / Perchero plegable				
ST25600	Stender "mini" FLAT L 60 cm ruote Ø 5 cm regolabile con giunto a scatto, cromato "Mini" FLAT garment rail L 60 cm with castors Ø 5 cm, adjustable by metallic pin, chrome finish "Mini" FLACHER Rollständer L 60 cm mit Rollen Ø 5 cm, Höhenverstellung durch Schnäpper, verchromt Penderie "Mini" PLAT L 60 cm avec roulettes Ø 5 cm, réglable par loquet, chromé "Mini" Perchero PLANO L 60 cm ruedas Ø 5 cm regulable mediante regulador, cromado	126.00	1 pz. 1 ea 1 Stück 1 unité 1 unidad	NEW
214/80	Stender pieghevole L 140 cm con ruote Ø 8 cm, tubo quadro, cromato Fold-away Rail L 140 cm with castors Ø 8 cm, square section, chrome finish Rollständer L 140 cm, mit Rollen Ø 8 cm, Vierkanthor, verchromt Penderie pliable L 140 cm avec roulettes Ø 8 cm, pied tube carré, chromé Perchero plegable L 140 cm con ruedas Ø 8 cm, tubo cuadrado, cromado	143.00	1 pz. 1 ea 1 Stück 1 unité 1 unidad	
ST21214	Stender pieghevole L 140 cm con ruote Ø 8 cm, regolabile con giunto a scatto, tubo quadro, cromato Fold-away Rail L 140 cm with castors Ø 8 cm, adjustable by pull-out system, square section, chrome finish Rollständer L 140 cm mit Rollen Ø 8 cm, Höhenverstellung durch Schnäpper, Vierkanthor, verchromt Penderie pliable L 140 cm avec roulettes Ø 8 cm, réglable par loquet, pied tube carré, chromé Perchero plegable L 140 cm con ruedas Ø 8 cm, regulable mediante regulador, tubo cuadrado cromado	160.00	1 pz. 1 ea 1 Stück 1 unité 1 unidad	
ST21214/S	scatola Fold-away Rail L 140 cm with castors Ø 8 cm, adjustable by pull-out system, square section, chrome finish, packed in carton Rollständer L 140 cm mit Rollen Ø 8 cm, Höhenverstellung durch Schnäpper, Vierkanthor, verchromt, im Karton Penderie pliable L 140 cm avec roulettes Ø 8 cm, réglable par loquet, pied tube carré, chromé, dans carton Perchero plegable L 140 cm con ruedas Ø 8 cm, regulable mediante regulador, tubo cuadrado cromado, en carton	174.00	1 pz. 1 ea 1 Stück 1 unité 1 unidad	
ST2121402	Fold-away Rail L 140 cm with castors Ø 8 cm, adjustable by pull-out system, square section, charcoal grey embossed Rollständer L 140 cm mit Rollen Ø 8 cm, Höhenverstellung durch Schnäpper, Vierkanthor, grau anthrazit gaufriert Penderie pliable L 140 cm avec roulettes Ø 8 cm, réglable par loquet, pied tube carré, gris anthracite gaufré Perchero plegable L 140 cm con ruedas Ø 8 cm, regulable mediante regulador, tubo cuadrado, gris	174.00	1 pz. 1 ea 1 Stück 1 unité 1 unidad	NEW
ST15214	Stender pieghevole L 100 cm con ruote Ø 8 cm, regolabile con giunto a scatto, tubo quadro, cromato Fold-away Rail L 100 cm with castors Ø 8 cm adjustable by pull-out system, square section, chrome finish Rollständer L 140 cm mit Rollen Ø 8 cm, Höhenverstellung durch Schnäpper, Vierkanthor, verchromt Penderie pliable L 100 cm roulettes Ø 8 cm, réglable par loquet, pied tube carré, chromé Perchero plegable L 100 cm con ruedas Ø 8 cm, regulable mediante regulador, tubo cuadrado, cromado	156.00	1 pz. 1 ea 1 Stück 1 unité 1 unidad	
ST15214/S	scatola Fold-away Rail L 100 cm with castors Ø 8 cm adjustable by pull-out system, square section, chrome finish, in carton Rollständer L 140 cm mit Rollen Ø 8 cm, Höhenverstellung durch Schnäpper, Vierkanthor, verchromt, im Karton Penderie pliable L 100 cm roulettes Ø 8 cm, réglable par loquet, pied tube carré, chromé, dans carton Perchero plegable L 100 cm con ruedas Ø 8 cm, regulable mediante regulador, tubo cuadrado, cromado, en carton	170.00	1 pz. 1 ea 1 Stück 1 unité 1 unidad	



Stender Collection FID

Articolo Item Artikel Article Codigo	Descrizione / Description / Beschreibung / Déscription/ Descripcion	CHF - Prezzo unitario - Price per piece - Preis pro Stück - Prix par pièce - Precio para unidad	Confezione Pack Abnahme Unité Unidad
410/R100S	Stender pieghevole L100 cm, con ruote Ø 10 cm, regolabile, cromato, in scatola Repsfrend L 100 cm, with castors Ø 10 cm, adjustable, chrome finish, in carton Reiserollständer L 100 cm, mit Rollen Ø 10 cm, höhenverstellbar, verchromt, im Karton Penderie pliable L 100 cm, avec roulettes Ø 10 cm, réglable, chromé, dans carton Perchero plegable L 100 cm, con ruedas Ø 10 cm, regulable, cromado, en caja	230.00	1 pz. 1 ea 1 Stück 1 unité 1 unidad
Stender doppio / Double garment rail / Doppelständer / Penderie double / Perchero doble			
204	Stender doppio L 140 cm, senza ruote, regolabile con giunto a scatto, cromato Double garment rail L 140 cm, without castors, adjustable by pull-out system, chrome finish Doppelständer L 140 cm, ohne Rollen, Höhenverstellung durch Schnäpper, verchromt Penderie double L 140 cm, sans roulettes, réglable par loquet, chromé Perchero doble L 140 cm, sin ruedas, regulable mediante regulador, cromado	215.00	1 pz. 1 ea 1 Stück 1 unité 1 unidad
204R50	Stender doppio L 140 cm, con ruote Ø 5 cm, regolabile con giunto a scatto, cromato Double garment rail L 140 cm, with castors Ø 5 cm, adjustable by pull out system, chrome finish Doppelständer L 140 cm, mit Rollen Ø 5 cm, Höhenverstellung durch Schnäpper, verchromt Penderie double L 140 cm, avec roulettes Ø 5 cm, réglable par loquet, chromé Perchero doble L 140 cm, con ruedas Ø 5 cm, regulable mediante regulador, cromado	252.00	1 pz. 1 ea 1 Stück 1 unité 1 unidad
204R80	Stender doppio L 140 cm, con ruote Ø 8 cm, regolabile con giunto a scatto, cromato Double garment rail L 140 cm, with castors Ø 8 cm, adjustable by pull out system, chrome finish Doppelständer L 140 cm, mit Rollen Ø 8 cm, Höhenverstellung durch Schnäpper, verchromt Penderie double L 140 cm, avec roulettes Ø 8 cm, réglable par loquet, chromé Perchero doble L 140 cm, con ruedas Ø 8 cm, regulable mediante regulador, cromado	266.00	1 pz. 1 ea 1 Stück 1 unité 1 unidad
204600	Barra intermedia L 140 cm Cross bar L 140 cm Zwischenstange L 140 cm Barre intermédiaire L 140 cm Barra intermedia L 140 cm	82.00	1 pz. 1 ea 1 Stück 1 unité 1 unidad
ST20510	Stender doppio L 120 cm, senza ruote, regolabile con maniglietta, cromato Double garment rail L 120 cm, without castors, adjustable by metallic screw, chrome finish Doppelständer L 120 cm, ohne Rollen, Höhenverstellung durch Schraube, verchromt Penderie double L 120 cm, sans roulettes, réglable par petite poignée, chromé Perchero doble L 120 cm, sin ruedas, regulable con asas, cromado	194.00	1 pz. 1 ea 1 Stück 1 unité 1 unidad
ST205600	Barra intermedia L 120 cm per ST20510 Cross bar L 120 cm for ST20510 Zwischenstange L 120 cm für ST20510 Barre intermédiaire L 120 cm pour ST20510 Barra intermedia L 120 cm para ST20510	82.00	1 pz. 1 ea 1 Stück 1 unité 1 unidad
ST209R80B	Stender doppia barra L 143 cm con ruote Ø 8 cm, regolabile con giunto, cromato Twin Top Rail L 143 cm with castors Ø 8 cm, adjustable by metallic pin, chrome finish Rollständer L 143 cm mit Rollen Ø 8 cm, Höhenverstellung durch Schnäpper, mit 2 Tragestangen, verchromt Penderie double barre L 143 cm avec roulettes Ø 8 cm, réglable par loquet, chromé Perchero doble barra L 143 cm con ruedas Ø 8 cm, regulable mediante regulador, cromado	187.00	1 pz. 1 ea 1 Stück 1 unité 1 unidad
Stender semicircolare / Semicircular garment rail / Halbkreis-Ständer / Penderie semicirculaire / Perchero semicircular			
207/120	Stender semicircolare L 120, H 120 cm, cromato Semicircular garment rail L 120, H 120 cm, chrome Halbkreis-Ständer L 120, H 120 cm, verchromt Penderie semicirculaire L 120, H 120 cm, chromée Perchero semicircular L 120, H 120 cm, cromado	142.00	1 pz. 1 ea 1 Stück 1 unité 1 unidad
207/150	Stender semicircolare L 120, H 150 cm, cromato Semicircular garment rail L 120, H 150 cm, chrome Halbkreis-Ständer L 120, H 150 cm, verchromt Penderie semicirculaire L 120, H 150 cm, chromée Perchero semicircular L 120, H 150 cm, cromado	142.00	1 pz. 1 ea 1 Stück 1 unité 1 unidad
Stender accatastabile / Stackable garment rail / Rollständer, stapelbar / Penderie empilable / Perchero amontenable			
213/80CR	Stender accatastabile L 130 cm con ruote Ø 8 cm, tubo quadro, cromato Stackable Garment Rail L 130 cm with castors Ø 8 cm, square section, chrome finish Rollständer, Stapelbar L 130 cm, mit Rollen Ø 8 cm, Vierkantrohr, verchromt Penderie empilable L 130 cm avec roulettes Ø 8 cm, pied tube carré, chromé Perchero amontenable L 130 cm con ruedas Ø 80, tubo cuadrado, cromado	164.00	1 pz. 1 ea 1 Stück 1 unité 1 unidad
209/Z/80	Stender a "Z" fisso L 143 cm con ruote Ø 8 cm, cromato Fix "Z" garment rail L 143 cm with castors Ø 8 cm, chrome finishing "Z" Rollständer, starre Höhe, L 143 cm mit Rollen Ø 8 cm, verchromt Penderie "Z", hauteur fixe, L 143 cm avec roulettes Ø 8 cm, chromé Perchero "Z", altura fija, L 143 cm con ruedas Ø 8 cm, cromado	164.00	1 pz. 1 ea 1 Stück 1 unité 1 unidad
Stender tubo quadro / Square tube garment rail / Rollständer, Vierkantrohr / Penderie pied tube carré / Perchero tubo cuadrado			
ST251300	Stender in tubo quadro 25x25 mm, cromato L 100, H 130 cm - con possibilità di mettere un ripiano sopra Garment rail, square section 25x25 mm, chrome L 100, H 130 cm - Upper wooden shelf can be installed on Ständer, vierkantrohr 25x25 mm, verchromt L 100, H 130 cm - Fachboden kann auf Wunsch darauf montiert werden Penderie, pied tube carré 25x25 mm, chromé L 100, H 130 cm - tablette supérieure peut être montée Perchero, tubo cuadrado 25x25 mm, cromado L 100, H 130 cm - se puede montar un estante superior	138.00	1 pz. 1 ea 1 Stück 1 unité 1 unidad

NEW



Stender Collection FID

Articolo Item Artikel Article Codigo	Descrizione / Description / Beschreibung / Déscription/ Descripcion	CHF - Prezzo unitario - Price per piece - Preis pro Stück - Prix par pièce - Precio para unidad	Confezione Pack Abnahme Unité Unidad	
ST251309	Stender in tubo quadro 25x25 mm, Bianco L 100, H 130 cm - con possibilità di mettere un ripiano sopra Garment rail, square section 25x25 mm, white L 100, H 130 cm - Upper wooden shelf can be installed on Ständer, vierkantrhor 25x25 mm, weiss L 100, H 130 cm - Fachboden kann auf Wunsch darauf montiert werden Penderie, pied tube carré 25x25 mm, blanc L 100, H 130 cm - tablette supérieure peut être monté Perchero, tubo cuadrado 25x25 mm, blanco L 100, H 130 cm - se puede montar un estante superior	138.00	1 pz. 1 ea 1 Stück 1 unité 1 unidad	NEW
ST251600	ripiano sopra Adjustable Garment rail, square section 25x25 mm, chrome L 100, H 130 cm - Upper wooden shelf can be installed on Ständer, Höhenverstellung, vierkantrhor 25x25 mm, verchromt L 100, H 130 cm - Fachboden kann auf Wunsch darauf montiert werden Penderie réglable, pied tube carré 25x25 mm, chromé L 100, H 130 cm - tablette supérieure peut être monté Perchero regulable, tubo cuadrado 25x25 mm, cromado L 100, H 130 cm - se puede montar un estante	194.00	1 pz. 1 ea 1 Stück 1 unité 1 unidad	NEW
ST251320	Coppia mensole, cromo lucido Shelf brackets, chrome Konsole Paar, verchromt Consoles, chromées Cartelas, cromado	42.50	1 pz. 1 ea 1 Stück 1 unité 1 unidad	NEW
ST251329	Coppia mensole, bianco RAL 9010 Shelf brackets, white RAL 9010 Konsole Paar, weiss RAL 9010 Consoles, blanc RAL 9010 Cartelas, blanco RAL 9010	42.50	1 pz. 1 ea 1 Stück 1 unité 1 unidad	NEW
GO4010009	Ripiano da 100x40x1,8 cm, bianco Shelf 100x40x1,8 cm, white Boden 100x40x1,8 cm, weiss Tablette 100x40x1,8 cm, blanc Estante 100x40x1,8 cm, blanco	35.50	1 pz. 1 ea 1 Stück 1 unité 1 unidad	NEW
PIANTANE / MERCHANDISING UNITS / ABHÄNGERSTÄNDER / PORTANTS / PERCHEROS				
PIANTANE TUBO TONDO / MERCHANDISING UNITS, ROUND SECTION / ABHÄNGERSTÄNDER, RUNDROHR PORTANTS, TUBE RONDE / PERCHEROS, TUBO REDONDO				
ST27500	Piantana a 2 braccia dritte, regolabile, cromato Merchandising Unit with 2 straight arms, adjustable, chrome finish Abhängeständer mit 2 geraden Armen, höhenverstellbar, verchromt Portant 2 bras droits, réglable, chromé Perchero 2 brazos rectos, regulable, cromado	109.00	1 pz. 1 ea 1 Stück 1 unité 1 unidad	
ST27550	Piantana a 2 braccia (1 dritta e 1 inclinata), regolabile, cromato Merchandising Unit with 2 arms (1 straight and 1 sloping), adjustable, chrome finish Abhängeständer mit 2 Armen (1 Gerade und 1 Schrägarm), höhenverstellbar, verchromt Portant 2 bras (1 droit et 1 incliné), réglable, chromé Perchero 2 brazos (1 brazo recto y 1 inclinado), regulable, cromado	115.00	1 pz. 1 ea 1 Stück 1 unité 1 unidad	
ST27600	Piantana a 2 braccia inclinate, regolabile, cromato Merchandising Unit with 2 sloping arms, adjustable, chrome finish Abhängeständer mit 2 Schrägarmen, höhenverstellbar, verchromt Portant 2 bras inclinés, réglable, chromé Perchero 2 brazos inclinados, regulable, cromado	118.00	1 pz. 1 ea 1 Stück 1 unité 1 unidad	
274	Piantana a 4 braccia inclinate, cromato 4-waterfall arms Merchandising Unit, chrome finish Kreuzständer mit 4 Schrägarme, verchromt Portant multi-bras, 4 bras inclinés, chromé Perchero, 4 brazos inclinados, cromado	211.00	1 pz. 1 ea 1 Stück 1 unité 1 unidad	
31122	Piedino Regolabile M10x25 per piantane tubo tondo Adjustable feet M10x25 for round tube section merchandising unit Fuß M10x25, höhenverstellbar für Abhängeständer, rundrohr Vérin réglable M10x25 pour portants, tube ronde Nivelador M10x25 para percheros, tubo redondo	0.70	1 pz. 1 ea 1 Stück 1 unité 1 unidad	
482	Piantana a 3 braccia inclinate, base 5 ruote cromata 3-waterfall arms display rail, base with 5 castors, chrome finish Abhängeständer mit 3 Schrägarme, mit 5 Rollen, verchromt Portant 3 bras inclinés, base à 5 pieds avec roulettes, chromée Perchero 3 brazos inclinados, base 5 pies con ruedas, cromado	150.00	1 pz. 1 ea 1 Stück 1 unité 1 unidad	
483	Piantana a 3 braccia dritte, base 5 ruote, cromata 3-straight arms display rail, base with 5 castors, chrome finish Abhängeständer mit 3 gerade Arme, mit 5 Rollen, verchromt Portant 3 bras droits, base à 5 pieds avec roulettes, chromé Perchero 3 brazos rectos, base 5 pies con ruedas, cromado	144.00	1 pz. 1 ea 1 Stück 1 unité 1 unidad	
484	Piantana a 4 braccia piegate-inclinate, base 5 ruote cromata 4-waterfall cranked arms display rail, base on 5 castors, chrome finish Abhängeständer mit 4 gewinkelte Schrägarme, mit 5 Rollen, verchromt Portant 4 bras inclinés, base à 5 pieds avec roulettes, chromée Perchero 4 brazos inclinados, base 5 pies con ruedas, cromado	167.00	1 pz. 1 ea 1 Stück 1 unité 1 unidad	



Stender Collection FID

Articolo Item Artikel Article Codigo	Descrizione / Description / Beschreibung / Déscription/ Descripcion	CHF - Prezzo unitario - Price per piece - Preis pro Stück - Prix par pièce - Precio para unidad	Confezione Pack Abnahme Unité Unidad
485	Piantana a 4 braccia piegate-dritte, base 5 ruote cromata 4-cranked straight arms display rail, base with 5 castors, chrome finish Abhängeständer mit 4 geraden Armen, gewinkelt, mit 5 Rollen, verchromt Portant 4 bras droites pliés, base à 5 pieds avec roulettes, chromée Perchero 4 brazos rectos, base 5 pies con ruedas, cromado	160.00	1 pz. 1 ea 1 Stück 1 unité 1 unidad
486	Piantana a 3 braccia con anelli portacinture, base 5 ruote cromata Display Stand, 3 arm carousel top, base with 5 castors, chrome finish Abhängeständer, mit 3 Armen mit Hakenringen, mit 5 Rollen, verchromt Portant 3 tourniquets, base à 5 pieds avec roulettes, chromée Perchero, 3 brazos con estrellas giratorias, base 5 pies con ruedas, cromado	276.00	1 pz. 1 ea 1 Stück 1 unité 1 unidad
266/1	Piantana portacinture/cravatte con anello 12 braccetti, base 5 ruote, cromata Display Stand, 12 arm carousel, base with 5 castors, chrome finish Gürtel-Foulard und Kravattenständer mit Ring 12 Haken, mit 5 Rollen, Verchromt Portant porte-cravates, tourniquet à 12 bras, base à 5 pieds avec roulettes, chromé Perchero para corbatas y cinturones con aro 12 brazos, base 5 pies, cromado	143.00	1 pz. 1 ea 1 Stück 1 unité 1 unidad
266/2	Piantana portacinture/cravatte con anello 20 braccetti, base 5 ruote, cromata Display Stand, 20 arm carousel, base with 5 castors, chrome finish Gürtel-Foulard und Kravattenständer mit Ring 20 Haken, mit 5 Rollen, Verchromt Portant porte-cravates, tourniquet à 20 bras, base à 5 pieds avec roulettes, chromé Perchero para corbatas y cinturones con aro 20 brazos, base 5 pies, cromado	162.00	1 pz. 1 ea 1 Stück 1 unité 1 unidad
266/P	Anello portacinture con 12 braccetti Ø 33 cm 12 Arm Carousel Ø 33 cm Ring für Gürtel mit 12 Haken Ø 33 cm Tourniquet porte-cravates à 12 bras Ø 33 cm Aro para portacinturones 12 brazos Ø 33 cm	47.00	1 pz. 1 ea 1 Stück 1 unité 1 unidad
266/G	Anello portacinture con 20 braccetti Ø 55 cm 20 Arm Carousel Ø 55 cm Ring für Gürtel mit 20 Haken Ø 55 cm Tourniquet porte-cravates à 20 bras Ø 55 cm Aro para portacinturones 20 brazos Ø 55 cm	65.00	1 pz. 1 ea 1 Stück 1 unité 1 unidad
ST26510	Piantana circolare, base 5 ruote, cromata Circular rail, base with 5 castors, chrome finish Ringständer, mit 5 Rollen, verchromt Portant ronde, base à 5 pieds avec roulettes, chromé Perchero redondo, base 5 pies, cromado	235.00	1 pz. 1 ea 1 Stück 1 unité 1 unidad
SL99926510600	Anello Ø 60 cm per Piantana circolare ST26510 Circular Carousel Top Ø 60 cm for circular rail ST26510 Ring Ø 60 cm für Ringständer ST26510 Cercle Ø 60 cm pour portant ronde ST26510 Aro Ø 60 cm para perchero redondo ST26510	149.00	1 pz. 1 ea 1 Stück 1 unité 1 unidad
265/70	Piantana circolare Ø 73 cm, base 5 ruote, cromata Circular rail Ø 73 cm, base with 5 castors, chrome finish Ringständer Ø 73 cm, mit 5 Rollen, verchromt Portant ronde Ø 73 cm, base à 5 pieds avec roulettes, chromé Perchero redondo Ø 73 cm, base 5 pies, cromado	195.00	1 pz. 1 ea 1 Stück 1 unité 1 unidad
265750	Anello Ø 73 cm per Piantana circolare Circular Carousel Top Ø 73 cm for circular rail Ring Ø 73 cm für Ringständer Cercle Ø 73 cm pour portant ronde Aro Ø 73 cm para perchero redondo	98.00	1 pz. 1 ea 1 Stück 1 unité 1 unidad
ST26800	Piantana circolare Ø 80 cm, altezza fissa, base 5 ruote, cromata Circular rail Ø 80 cm, fixed height, base with 5 castors, chrome finish Ringständer Ø 80 cm, starre Höhe, mit 5 Rollen, verchromt Portant ronde Ø 80 cm, hauteur fixe, base à 5 pieds avec roulettes, chromé Perchero redondo Ø 80 cm, altura fija, base 5 ruedas, cromado	238.00	1 pz. 1 ea 1 Stück 1 unité 1 unidad
268	Piantana circolare Ø 80 cm, base 5 ruote Ø 5 cm, regolabile con giunto a scatto, cromata Circular rail Ø 80 cm, base with 5 castors Ø 5 cm, adjustable by pull out system, chrome finish Ringständer Ø 80 cm, mit 5 Rollen Ø 5 cm, Höhenverstellung durch Schnäpper, verchromt Portant ronde Ø 80 cm, base à 5 pieds avec roulettes Ø 5 cm, réglable par loquet, chromé Perchero redondo Ø 80 cm, base 5 ruedas Ø 5 cm, regulable mediante regulador, cromado	255.00	1 pz. 1 ea 1 Stück 1 unité 1 unidad
268/80	Piantana circolare Ø 80 cm, base 5 ruote Ø 8 cm, regolabile con giunto a scatto, cromata Circular rail Ø 80 cm, base with 5 castors Ø 8 cm, adjustable by pull out system, chrome finish Ringständer Ø 80 cm, mit 5 Rollen Ø 8 cm, Höhenverstellung durch Schnäpper, verchromt Portant ronde Ø 80 cm, base à 5 pieds avec roulettes Ø 8 cm, réglable par loquet, chromé Perchero redondo Ø 80 cm, base 5 ruedas Ø 8 cm, regulable mediante regulador, cromado	290.00	1 pz. 1 ea 1 Stück 1 unité 1 unidad
269	Piantana circolare Ø 100 cm, regolabile con giunto a scatto, base 5 ruote Ø 5 cm, cromata Circular rail Ø 100 cm, adjustable by pull out system, base with 5 castors Ø 5 cm, chrome finish Ringständer Ø 100 cm, Höhenverstellung durch Schnäpper, mit 5 Rollen Ø 5 cm, verchromt Portant tourniquet Ø 100 cm, réglable par loquet, base à 5 pieds avec roulettes Ø 5 cm, chromé Perchero redondo Ø 100 cm, regulable mediante regulador, base 5 ruedas Ø 5 cm, cromado	278.00	1 pz. 1 ea 1 Stück 1 unité 1 unidad



Stender Collection FID

Articolo Item Artikel Article Codigo	Descrizione / Description / Beschreibung / Déscription/ Descripcion	CHF - Prezzo unitario - Price per piece - Preis pro Stück - Prix par pièce - Precio para unidad	Confezione Pack Abnahme Unité Unidad
ST00552	Braccio a gradino Stepped arm Stufeneinsatz Bras à gradin Brazo escalon	61.00	1 pz. 1 ea 1 Stück 1 unité 1 unidad
ST00553	Braccio inclinato Sloping arm Schrägeinsatz Bras incliné Brazo inclinado	44.00	1 pz. 1 ea 1 Stück 1 unité 1 unidad
ST00560	Braccio piegato-inclinato sinistro Waterfall cranked arm, left Schräger Einsatz gewinkelt links Bras croix incliné à gauche Brazo izquierdo plegado	61.00	1 pz. 1 ea 1 Stück 1 unité 1 unidad

Preise ab unseren Lokalitäten. Preisänderung vorbehalten.
Diese Preisliste annulliert die vorhergehende.
Lieferfrist ca. 4 Wochen ab Auftragsbestätigung. **Exkl. MwSt**
Fotos, Farben und Grössen können vom Original abweichen.

Prix départ de nos locaux. Sous réserve de modifications. **TVA non incluse**
La présente liste annule et remplace toute précédente liste.
Délai de livraison hors stock, env. 4 sem. dès confirmation commande.
Photos, couleurs et mesures non contractuelles.

DITTA DISPLAY

info@dittadisplay.ch
www.dittadisplay.ch

TEL 021 691 12 12 FAX 021 691 13 13
TEL 043 495 06 61 FAX 043 495 06 62

Ch. des Champs-Courbes 1,
ZI En Vallaire Est, 1024 Ecublens VD 55